

University of Ljubljana
Faculty of Computer
and Information Science



Survey of Activities

in 2013

Faculty of
Computer and
Information
Science
University of
Ljubljana

**Survey of
Activities
in 2013**

Ljubljana
2014

Contents

Foreword **4**

ABOUT FRI 6

General Information **7**

How to Reach Ljubljana **9**

KEY ACHIEVEMENTS 14

EDUCATIONAL PROGRAMMES 18

University Study Programme Computer and Information Science **21**

Professional Study Programme Computer and Information Science **24**

Interdisciplinary University Study Programme Computer Science and Mathematics **27**

Interdisciplinary University Study Programme Administrative Information Systems **29**

Master Study Programme Computer and Information Science **31**

Master Study Programme Computer Science and Mathematics **33**

Doctoral programmes **36**

RESEARCH 38

Laboratory for Computer Graphics and Multimedia **41**

Laboratory for Biomedical Computer Systems and Imaging **44**

Laboratory of Adaptive Systems and Parallel Processing **48**

Laboratory for Computer Architecture **51**

Computer Communications Laboratory **55**

Computer Structures and Systems Laboratory **60**

Information Systems Laboratory **65**

Laboratory of e-Media **70**

Laboratory for Data Technologies **73**

Laboratory for Integration of Information Systems **79**

Laboratory for Algorithms and Data Structures **84**

Laboratory for Architecture and Signal Processing **86**

Software Engineering Laboratory **89**

Computer Vision Laboratory **92**

Visual Cognitive Systems Laboratory **97**

Artificial Intelligence Laboratory **103**

Laboratory for Cognitive Modeling **108**

Bioinformatics Laboratory **112**

Laboratory for Mathematical Methods in Computer and Information Science **118**

Laboratory for Cryptography and Computer Security **122**

Foreword



This booklet provides some basic information on the Faculty of Computer and Information Science at the University of Ljubljana. The Faculty is the leading institution in the field of computer and information science in Slovenia. Since its first study programme in computer science began in 1973, it has had a lengthy roster of alumni, some of whom have achieved distinction in academic and professional circles in Slovenia and abroad. The Faculty has a number of active research groups that attract funding from various EU and international programmes as well as funding from Slovenian and foreign industry. Due to the high demand for computer and information science graduates, the interest for studies on the Faculty is steadily growing. We actively promote computer and information science study by offering free summer workshops for secondary and primary school students. During the academic year, we also provide assistance to selected secondary as well as primary schools in the form of after-class activities. In addition to the core – computer science, recently implemented interdisciplinary study programmes, designed according to the Bologna principles and offered jointly with selected other faculties of the University of Ljubljana and other universities enable an interdisciplinary approach to computer science education and are meant to attract students from diverse educational and geographical backgrounds. We also aim to further open our studies and make them accessible to international students. Part of the Master's Studies and the entire Doctoral Programme is conducted in English and particular attention is given to attracting promising international doctoral students.

In the age of globalization, the Faculty faces increasing competition in all areas. In recent years we have expanded our research competences to fit a wider spectrum of promising technical areas by attracting experienced researchers and teachers. The Faculty's most pressing problem in the last years, the shortage of space, is about to be resolved. The construction of the new Faculty building, which started in 2010 and was funded by EU, will be finished in summer 2014, when we will move to the new premises. This will allow our Faculty to accelerate the growth and improve the

quality, both of education and research activities. In addition to fostering basic and applied research, our Faculty will use the momentum of the new building to establish and deepen the collaboration with the industry. We will improve the knowledge and technology transfer between academia and the industry with new partnership models and we will invite leading high-tech companies to establish innovation centres within the Faculty. This way, we will not only increase the amount of research funded by industry, but we will also make study programmes more attractive and more related to actual, practical problems.

Special attention will be given to the innovation segment. In the last few years, our students have achieved excellent results in various competitions and developed ground-breaking projects. In the new building, we will establish the FRI Innovation Garage, where the best and most innovative students will be offered working space and mentoring support, which will lead to innovative projects, start-ups and spin-offs. With all these activities our aim is to make the study and research at our Faculty more appealing.

I hope that this booklet will forge new links with the international computer science community, which is a prerequisite for the Faculty to successfully continue its mission. I am inviting readers who find material in this booklet interesting to establish contact with our Faculty members.

Nikolaj Zimic

Dean

Faculty of Computer and Information Science



About FRI

General Information

Dean **Prof Nikolaj Zimic, PhD**

Vice Dean for Education **Prof Neža Mramor Kosta, PhD**

Vice Dean for Research **Prof Matjaž B. Jurič, PhD**

Vice Dean for Development **Prof Patricio Bulić, PhD**

Vice Dean for Economic Affairs **Prof Marko Bajec, PhD** (from 1 July 2013)

Secretary General **Nives Macerl**

Address:

University of Ljubljana
Faculty of Computer and Information Science
Tržaška cesta 25¹
SI-1001 Ljubljana
Slovenia

Phone: +386 1 476 84 11

Fax: +386 1 426 46 47

www: <http://www.fri.uni-lj.si/>

E-mail: name.surname@fri.uni-lj.si (for all teaching and research staff)

FRI

The Faculty of Computer and Information Science (FRI) was established in 1996 as an independent faculty of the University of Ljubljana. The undergraduate programme in computer science had commenced before, in 1973, when the faculty staff was engaged within the former Faculty of Electrical Engineering and Computer Science. The study programme first started as an elective programme after the second year of electrical

¹ In July 2014, Faculty of Computer and Information Science will move to the new building. The new address will be Večna pot 113, Ljubljana. Phone and fax numbers will change too. They will be available on the faculty web site: <http://www.fri.uni-lj.si/>

engineering study. In 1982 an independent four-year programme in computer science began. In 2008 the first generation of students was enrolled into the newly designed programs in computer science at all degrees, which are internationally comparable and follow the Bologna guidelines.

Up till now more than 3380 students have completed undergraduate programs in computer science and obtained an undergraduate university degree. At the graduate level, 386 Master's degrees (MSc) and 142 Doctoral degrees (PhD) in Computer and Information science have been awarded. Currently, there are about 1260 undergraduate and graduate students at the Faculty. The Faculty has 155 employees, of which 130 are teaching and research staff.

The central building that houses FRI is shared with the Faculty of Electrical Engineering. Twenty research laboratories are equipped with about 530 personal computers or workstations, and maintain a range of web servers and several medium-sized computational clusters. The Faculty has a joint library with the Faculty of Electrical Engineering. It houses a large collection of books, textbooks and journals and offers access to several on-line services and databases. Both faculties also share a publishing department that is engaged primarily in publishing textbooks for students.

How to Reach Ljubljana

BY AIR

The Ljubljana airport at Brnik is about 20 km North-West from the centre of Ljubljana (see Figure 2). It has fairly good connections with other European airports (Frankfurt, Munich, London, Zurich, Copenhagen, Paris, etc.) and is serviced by Adria, the national Slovenian air carrier, as well as number of other major European airlines.

BY PASSENGER CAR

Ljubljana is connected to all neighbouring countries by a good highway system.

BY AIR AND RAIL

Via Austria: By plane to Vienna, Graz or Klagenfurt airport and by car, shuttle (such as GoOpti.com) or train to Ljubljana (direct trains go twice daily on weekdays).

Via Germany: By plane to Munich or Frankfurt and by train, car, shuttle (such as GoOpti.com) or plane to Ljubljana (a direct train goes once every day, there are two flights daily from Munich and Frankfurt to Ljubljana).

Via Croatia: By plane to Zagreb and by train, shuttle (such as GoOpti.com) or car to Ljubljana.

Via Italy: By plane to Venice or Trieste and by car or shuttle (such as GoOpti.com) to Ljubljana.

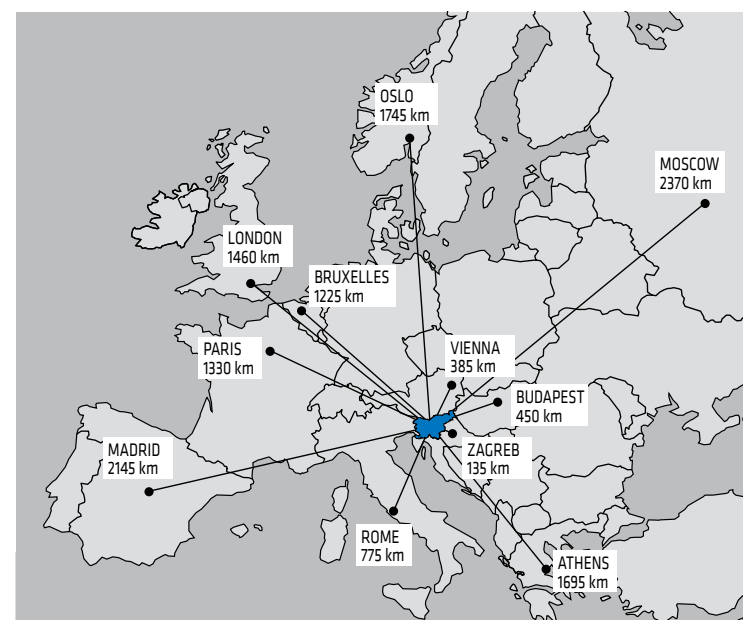

Figure 1: Slovenia in Europe

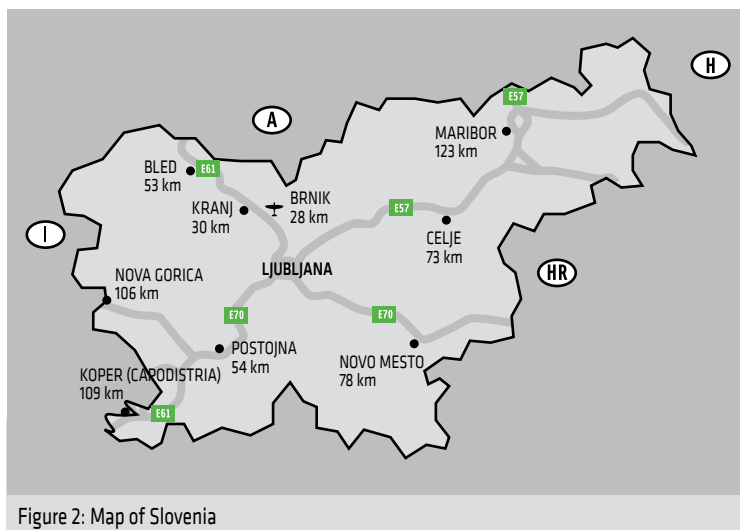

Figure 2: Map of Slovenia

BY RAIL

Ljubljana has good railway links with Austria (Vienna, Klagenfurt, Graz), Germany (Munich), Croatia (Zagreb, Rijeka) and Hungary (Budapest). The above-mentioned cities have good international connections with all large European cities. Traveling to Slovenia by rail from places further afield is of course less comfortable and not necessarily cheaper than air travel.

LOCATION OF FRI IN LJUBLJANA

FRI is located in the South-West of Ljubljana (Figure 3) within walking distance of most hotels in the centre of Ljubljana. To reach the Faculty from the centre you must take bus line 1 (direction "Mestni log") or 6 (direction "Dolgi most"). Map on Figure 4 shows how to reach FRI by car.

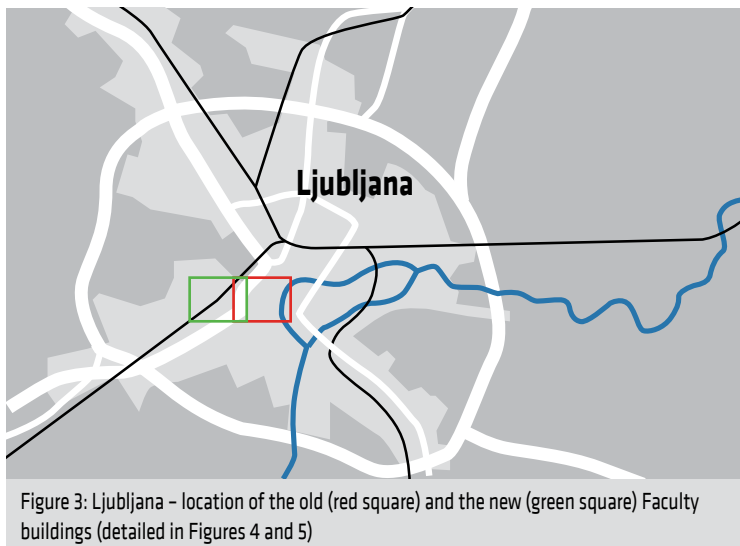

Figure 3: Ljubljana - location of the old (red square) and the new (green square) Faculty buildings (detailed in Figures 4 and 5)

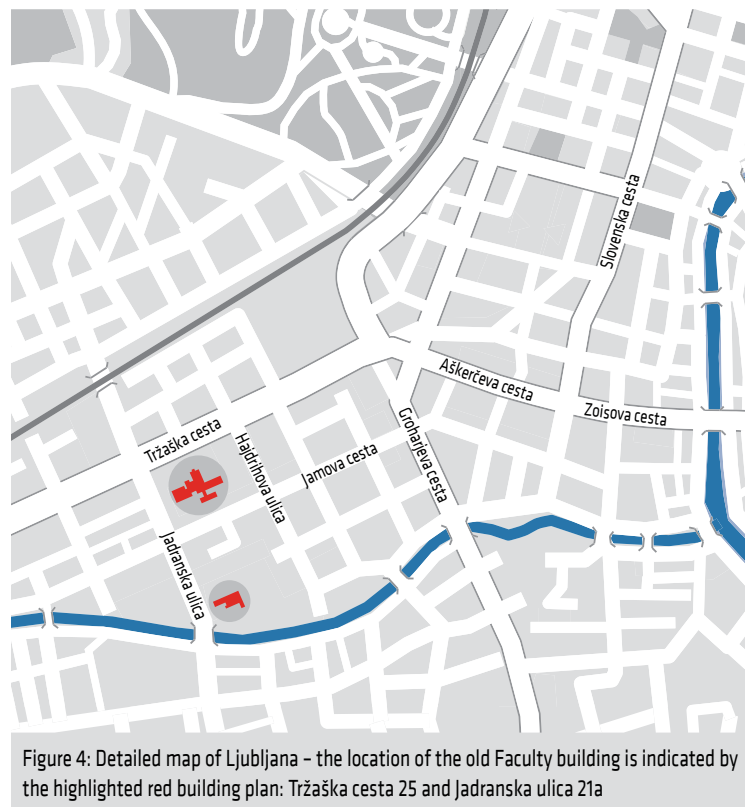

Figure 4: Detailed map of Ljubljana - the location of the old Faculty building is indicated by the highlighted red building plan: Tržaška cesta 25 and Jadranska ulica 21a

NEW FRI BUILDING

In July 2014, the Faculty of Computer and Information Science (FRI) will move to a new building. FRI will be located at the new site together with the Faculty of Chemistry and Chemical Technology (UL FKKT). The construction of the UL FRI and FKKT buildings is the largest national project receiving an EU ERDF grant. Besides being the largest project in the history of the University of Ljubljana, the project is also a significant contribution to Slovenian economic growth and development.

The new address will be Večna pot 113, Ljubljana. The new FRI building will be equipped with adequate IT and other support. It will offer 9245 m² of modern premises and provide a good basis for the future growth and development of the Faculty in all areas, including research, education and knowledge transfer.

The map on Figure 5 shows the location of the new building. Figures 6, 7 and 8 show the new building.

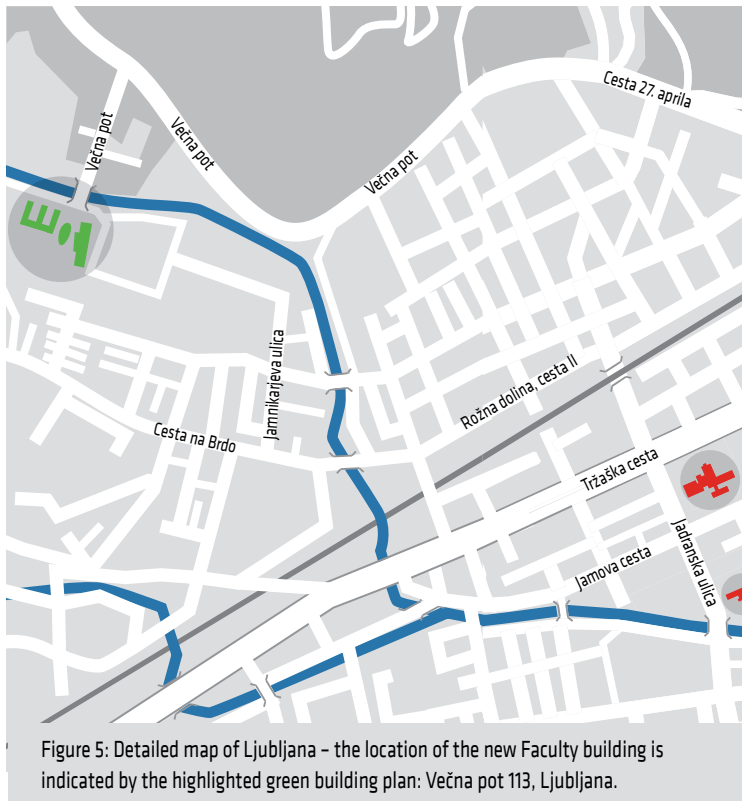

Figure 5: Detailed map of Ljubljana - the location of the new Faculty building is indicated by the highlighted green building plan: Večna pot 113, Ljubljana.

Figure 6: Faculty of Computer and Information Science new building - rear view.



Figure 7: Faculty of Computer and Information Science new building - front view.



Figure 8: Faculty of Computer and Information Science new building - interior.

Key Achievements

In 2013, the Faculty of Computer and Information Science was active in several fields, including the publishing of original scientific papers, research projects, awards and recognitions, and other achievements.

Original scientific papers published in SCI-Expanded indexed journals show a positive trend with a notable growth, as shown in the table below:

Period	Number of articles in A1 (first quarter)	Number of articles in A2 (second quarter)	Number of articles in A3 (third quarter)	Number of articles in A4 (fourth quarter)	Total
5 Year Period					
2007-2012	113	68	62	95	338
2008-2013	126	77	67	104	374
1 Year Period					
2012	23	16	10	18	67
2013	29	15	17	25	86

A positive growth can be observed along with citations, in particular citations in the Web of Science, as shown in the table below, which shows the citations in the last ten years:

Year	WoS Citations					Scopus Citations					Wos/Scopus Citations				
	TC	AC	CI	CIAu	NC	TC	AC	CI	CIAu	NC	TC	AC	CI	CIAu	NC
2004	178	26	152	69.79	197	321	47	274	134.02	355	340	48	292	142.27	385
2005	225	29	196	86.45	221	407	49	358	177.78	434	424	52	372	184.43	458
2006	299	32	267	114.34	272	478	43	435	212.35	507	497	45	452	221.36	539
2007	348	44	304	126.06	246	683	69	614	328.99	675	695	72	623	331.19	686
2008	404	55	349	180.66	322	781	91	690	402.95	804	802	93	709	412.77	829
2009	548	52	496	258.71	430	1051	63	988	598.79	1086	1062	64	998	602.99	1101
2010	709	84	625	302.71	508	1323	115	1208	708.41	1310	1345	118	1227	717.61	1330
2011	824	72	752	385.97	634	1516	125	1391	818.07	1455	1542	130	1412	826.74	1478
2012	1100	82	1018	504.31	820	1782	115	1667	947.05	1659	1824	119	1705	965.37	1710
2013	1144	39	1105	592.99	901	1702	75	1627	941.11	1605	1742	71	1671	955.64	1644
Total	5779	515	5264	2622.00	4542	10044	792	9252	5269.53	9886	10273	812	9461	5360.36	10157

TC - Total Citations; AC - Auto Citations; CI - Pure Citations; CIAu - Pure Citations per Author; NC - Normalized Citations

In 2013, the Faculty of Computer and Information Science was active in the following projects:

- 5 EU funded FP7 projects
- 2 Competence Centre projects funded by structural funds
- 7 other projects funded by structural funds
- 1 European Science Foundation (ESF) funded project
- 3 other international projects
- 6 national research programmes funded by the Slovenian Research Agency
- 14 national research projects funded by the Slovenian Research Agency
- 3 bilateral projects in cooperation with the Republic of Serbia and the USA
- 30 industry funded applied research projects

Professors and researches of the Faculty of Computer and Information Science won several awards and recognitions:

- Outstanding scientific achievements awarded by the Slovenian Academy of Sciences and Arts:
 - Expert system for fraud detection in the automobile insurance industry through the use of social networks - Lovro Šubelj, Štefan Furlan, Marko Bajec.
 - System for interactive learning in dialogue with a tutor - Danijel Skočaj, Matej Kristan and others.
 - Robust visual tracking using an adaptive coupled visual model - Luka Čehovin, Matej Kristan and Aleš Leonaridis.
- For University of Ljubljana Week, the Rector, Prof. Ivan Svetlik, PhD, gave out honorary awards for special achievements at the celebratory meeting of the UL Senate to teachers and students of the University of Ljubljana. Amongst the recipients were also the following FRI faculty members:
 - Prof. Matjaž Branko Jurič was awarded a gold medal for outstanding merit in the development of scientific and educational work;
 - Assist. Prof. Matej Kristan, PhD received an honorary certificate for young higher education teachers and associates for exceptional educational and research achievements;
 - The Dean, Prof. Nikolaj Zimic, PhD received a special recognition from the students;
 - The head of the Students' Office, Marija Valentinčič Pregelj, MA and Metka Runovc received an award from the students for the friendliest and most helpful professional staff.
- The award recipients of the Information Society 2013 international conference: Prof. Dušan Kodek, PhD (lifetime achievement) and Prof. Marko Bajec, PhD (current achievements).
- Assoc Prof. Patricio Bulić, PhD, Rok Česnovar, Robert Rozman and Andrej Štrancar have developed firmware for the product CubeSensors, which won the Hardware Battlefield global competition in Las Vegas.

- Prof. Matjaž B. Jurič, PhD received the prestigious IBM Champion for WebSphere Software Award.
- Prof. Denis Trček, PhD received the prestigious Fulbright Scholarship for several months of research at the University of Stanford in the 2014/2015 academic year.
- Prof. Zupan Blaž, PhD was awarded a Fulbright Scholarship to visit Baylor College of Medicine, Houston, in the academic year 2013/14.

The most notable awards and recognitions won by our exceptional students and their supervisors are the following:

- Martin Stražar received the University Prešeren Award for outstanding student research achievements for his thesis entitled 'Knowledge Discovery from a Genetic Regulatory Network Model (supervisor prof. Miha Mraz, PhD, co-supervisor Assist. Prof. Miha Moškon, PhD).
- The Faculty Prešeren Award went to Klemen Istenič for his thesis entitled 'Developing a Multi-Touch Surface using a RGBD Camera' (supervisor Assist. Prof. Danijel Skočaj, PhD) and Andrej Bukošek for his thesis entitled 'System for Parallel Execution of Data-Flow Graphs (supervisor Prof. Andrej Brodnik, PhD, co-supervisor Prof. Borut Robič, PhD).
- Timotej Lazar, a graduate of the interdisciplinary Computer Science and Mathematics study programme received an honorary certificate for outstanding academic achievements. He achieved an overall GPA of 9.8.
- Jure Žbontar won fifth place at «The Marinexplore and Cornell University Whale Detection Challenge».
- Slavko Žitnik and Marinka Žitnik cooperated on the discovering of gene interactions challenge in the «BioNLP Shared Task» competition and won the excellent first prize under the supervision of Prof. Blaž Zupan, PhD and Prof. Marko Bajec, PhD.
- Matic Končan and Žiga Šveglja won second place at the Days of Slovenian Informatics with their ecoDrivers project.
- Luka Maške and Matko Tatič, under the supervision of Assist. Prof. Matija Marolt, PhD, qualified for the ImagineCup finals (Drone Attack team).
- Marko Janković received the award for best doctoral topic at the IEEE RCIS 2013 conference (supervisor Prof. Marko Bajec, PhD).
- Marko Dolničar was awarded the prize for best student poster at the TERENA Networking Conference.
- Marinka Žitnik and her advisor Blaž Zupan received the first prize for their paper and presentation at 13th Conference on Critical Assessment of Massive Data Analysis (CAMDA-2013) in Berlin, Germany.

Educational Programmes



The academic year at the University of Ljubljana consists of the fall and the spring semester. Courses in the fall semester begin on October 1st and last for 15 full weeks. The spring semester courses start each year in the second half of February and end in the beginning of June, according to the current academic calendar of the University of Ljubljana. There are three examination periods: winter (from the end of the fall semester until the beginning of the spring semester), spring (a full month after the end of the spring semester) and fall (from mid-August until mid-September). At the Faculty of Computer and Information Science the courses consist of lectures, problem sessions (tutorials), laboratory work, and independent work assigned to the students. All courses last one semester and the student course load per semester, according to the European Credit Transfer System (ECTS), is 30 ECTS. In most study programmes, the work load is uniformly distributed among the courses, the majority of the courses at all levels have 6 ECTS.

The Faculty of Computer and Information Science participates in several international educational programmes, such as the European Union SOCRATES/ERASMUS programme and the CEEPUS programme which encourage student and teacher mobility between European universities, the Erasmus Mundus BASILEUS programme for exchange between European and Western Balkan universities, Erasmus Mundus LOTUS programme for exchange with SE Asia, Erasmus Mundus EMINTE programme for exchange with India and, as part of the Utrecht group of universities, in the EUROSA programme for exchange between European and South African universities. The study programmes of the Faculty of Computer and Information Science are registered with the Slovenian quality assurance agency for higher education and the European Federation of National Engineering Associations (FEANI) and they meet the criteria for the title EUR ING.

UNDERGRADUATE PROGRAMMES

The faculty of computer and information science offers the following first cycle programmes:

- University study programme Computer and Information Science,
- Professional study programme Computer and Information Science,
- Interdisciplinary university study programme Computer Science and Mathematics, offered jointly with the Faculty of Mathematics and Physics of the University of Ljubljana
- Interdisciplinary university study programme Administrative Information Systems, offered jointly with the Faculty of Administration of the University of Ljubljana

In the academic year 2014/2015 the newly accredited Interdisciplinary university study programme Multimedia will be offered jointly with the Faculty of Electrical Engineering of the University of Ljubljana for the first time.

All first cycle programmes last three years. They consist of six semesters of course work and have a total work load of 180 ECTS.

At the second cycle level, the following programmes are offered:

- Master study programme Computer and Information Science
- Interdisciplinary master study programme Computer Science and Mathematics, offered jointly with the Faculty of Mathematics and Physics of the University of Ljubljana
- Interdisciplinary master study programme Cognitive Sciences, offered jointly with the Faculty of Education, Faculty of Medicine and the Faculty of Arts of the University of Ljubljana, and several other European universities (University of Vienna, Technical University of Budapest, University of Zagreb and Comenius University in Bratislava)

In addition, the newly accredited Interdisciplinary master study programme Computer Science Education, prepared jointly with the Faculty of Education of the University of Ljubljana, will be offered in the academic year 2014/2015 for the first time.

The second cycle master study programmes last two years. They consist of 4 semesters of course work with a total work load of 120 ECTS.

FRI

University Study Programme Computer and Information Science

The programme leads to the degree “diplomirani inženir računalništva in informatike (UN)”, abbr. “dipl. inž. rač. in inf. (UN)”.

The first two years contain the core-curriculum courses including mathematics and theoretical foundations of computer science, one major elective course and one general elective course in the spring semester of the second year. In the third year, elective modules consisting of three courses each are offered. The student is required to choose two modules. In addition there is one compulsory course in each semester and one general elective course in the spring semester. The general electives are chosen from appropriate courses offered at the Faculty or within other study programmes at the University of Ljubljana. The study programme concludes with a diploma thesis with a work load of 6 ECTS in the last semester.

FIRST YEAR COURSES:

Semester	Title	ECTS
Fall	Programming 1	6
	Calculus	6
	Discrete Structures	6
	Introduction to Digital Circuits	6
	Physics	6
Spring	Programming 2	6
	Linear Algebra	6
	Fundamentals of Databases	6
	Computer Communications	6
	Human-Computer Interaction	6

SECOND YEAR COURSES:

Semester	Title	ECTS
Fall	Algorithms and Data Structures 1	6
	Computer Systems Architecture	6
	Probability and Statistics	6
	Operating Systems	6
	Introduction to Information Systems	6
Spring	Algorithms and Data Structures 2	6
	Theory of Information and Systems	6
	Computer Systems Organization	6
	General elective	6
	Major elective	6

SECOND YEAR MAJOR ELECTIVES:

Title	ECTS
Mathematical Modelling	6
Principles of Programming Languages	6
Computer Technologies	6

THIRD YEAR COURSES:

Semester	Title	ECTS
Fall	Artificial Intelligence	6
	Module 1, Course 1	6
	Module 1, Course 2	6
	Module 2, Course 1	6
	Module 2, Course 2	6
Spring	Economics and Entrepreneurship	6
	Module 1, Course 3	6
	Module 2, Course 3	6
	General elective	6
	Diploma thesis	6

ELECTIVE MODULES:

Information Systems

- Course 1: Electronic Business
- Course 2: Organization and Management
- Course 3: Business Intelligence

Management of Information Systems

- Course 1: Information Systems Development
- Course 2: Data Management Technologies
- Course 3: Informatics Planning and Management

Software Engineering

- Course 1: Software Development Processes
- Course 2: Web Programming
- Course 3: Software Engineering

Computer Networks

- Course 1: Computer Networks Modeling
- Course 2: Communication Protocols
- Course 3: Mobile and Wireless Networks

Computer Systems

- Course 1: Digital Design
- Course 2: Systems Reliability and Performance
- Course 3: Distributed Systems Computer

Algorithms and System Utilities

- Course 1: Computational Complexity and Heuristic Programming
- Course 2: System Software
- Course 3: Compilers

Artificial Intelligence

- Course 1: Intelligent Systems
- Course 2: Machine Perception
- Course 3: Development of Intelligent Systems

Multimedia

- Course 1: Computer Graphics and Game Technology
- Course 2: Multimedia Systems
- Course 3: Introduction to Design

Professional Study Programme Computer and Information Science

FRI

This application oriented study programme leads to the degree “diplomirani inženir računalništva in informatike (VS)”, abbr. “dipl. inž. rač. in inf. (VS)”.

The first year consists of core-curriculum courses. In the remaining two years the students choose from a structured list of major electives according to their individual interests and preferences, respecting the required prerequisites for each course. In addition to the core major electives with a workload of 6 ECTS each, the students can choose two out of a block of “technical” courses with a workload of 3 ECTS and with topics changing from year to year and ranging from specific programming languages to platforms or tools of current interest. The last semester consists of 6 ECTS of general electives, 18 ECTS of practical work within the industry and 6 ECTS for the diploma thesis. The total workload of 180 ECTS is divided into 66 ECTS of mandatory courses, 78 ECTS of major electives, 12 ECTS of general electives, 18 ECTS for practical work and 6 ECTS for the diploma thesis.

The general electives are chosen from appropriate courses offered at the Faculty or within other study programmes at the University of Ljubljana.

FIRST YEAR COURSES:

Semester	Title	ECTS
Fall	Introduction to Computer Science	6
	Programming I	6
	Computer Architecture	6
	Mathematics	6
	Discrete Structures	6
Spring	Programming II	6
	Databases	6
	Computer Communications	6
	Operating Systems	6
	Introduction to Probability and Statistics	6

ELECTIVE COURSES IN THE SECOND YEAR:

Semester	Title	Prerequisites	ECTS
Fall	Algorithms and Data Structures I		6
	Electronic and Mobile Business		6
	Databases II		6
	Information Systems		6
	Graphic Design		6
	Communications Protocols and Network Security		6
	Computer Organization		6
	Digital Circuits		6
	Computer Graphics		6
Artificial Intelligence		6	
Spring	User Interfaces		6
	Compilers and Virtual Machines	Algorithms and Data Structures I	6
	Algorithms and Data Structures II	Algorithms and Data Structures I	6
	Testing and Quality	Algorithms and Data Structures I	6
	Information Systems Development	Information Systems	6
	Multimedia Content Production	Graphic Design	6
	Digital Signal Processing		6
	Web Technologies	Algorithms and Data Structures I, Communications Protocols and Network Security	6
	Input-Output Systems	Algorithms and Data Structures I	6
	Digital Logic Design	Computer Organization, Digital Circuits and Algorithms and Data Structures I	6
Data Mining	Algorithms and Data Structures I, Artificial Intelligence	6	
Technical courses	Implementation of algorithms		3
	Computer tools, languages and platforms		3

ELECTIVE COURSES IN THE THIRD YEAR:

Semester	Title	Prerequisites	ECTS	
Fall	Project Practicum		6	
	Software Engineering	Algorithms and Data Structures I, Algorithms and Data Structures II	6	
	Information Systems Strategic Planning	Information Systems Development	6	
	Multimedia Content Production	Digital Signal Processing, Algorithms and Data Structures I, Algorithms and Data Structures II	6	
	Parallel and Distributed Systems and Algorithms	Algorithms and Data Structures I, Algorithms and Data Structures II	6	
	System Software	Algorithms and Data Structures I, Algorithms and Data Structures II	6	
	Process Automation	Input-Output Systems	6	
	Embedded Systems	Input-Output Systems, Algorithms and Data Structures II	6	
	Robotics and Machine Perception	Computer Graphics, Artificial Intelligence, Algorithms and Data Structures II	6	
	Game Technology and Virtual Reality	Algorithms and Data Structures I, Algorithms and Data Structures II, Computer Graphics, Artificial Intelligence	6	
	Decision Systems	Data Mining, Algorithms and Data Structures II	6	
	Numerical Methods		6	
	Spring	Industrial Practice		18
		General elective		6
Diploma Thesis			6	

FRI

Interdisciplinary University Study Programme Computer Science and Mathematics

This programme is offered jointly with the Faculty of Mathematics and Physics and is oriented towards theoretical computer science and topics in modern discrete and computational mathematics that are closely connected to it. The programme leads to the degree “diplomirani inženir računalništva in matematike (UN)”, abbr. “dipl. inž. rač. in mat. (UN)”.

The first two years contain mandatory core-curriculum courses. The third year contains three mandatory courses, one elective module from the University study programme Computer and Information Science, a major elective with a work load of 5 ECTS chosen among the courses offered at the Faculty of Mathematics and Physics, and general electives with a total load of 10 ECTS. The study programme concludes with a diploma thesis with a work load of 4 ECTS in the last semester.

FIRST YEAR COURSES:

Title	ECTS
Programming 1	6
Analysis 1	7
Discrete Structures 1	6
Introduction to Digital Circuits	6
Linear algebra	10
Programming 2	6
Fundamentals of Databases	6
Analysis 2	7
Discrete Structures 2	6

SECOND YEAR COURSES:

Title	ECTS
Algorithms and Data Structures 1	6
Computer Systems Architecture	6
Analysis 3	5
Operating Systems	6
Combinatorics	7
Optimization Methods	7
Algorithms and Data Structures 2	6
Principles of Programming Languages	6
Computer Communications	6
Topics in Mathematics	5

THIRD YEAR COURSES:

Title	ECTS
Numerical methods	7
Introduction to Artificial Intelligence	6
Probability and Statistics	10
Elective module, Course 1	6
Elective module, Course 2	6
Elective module, Course 3	6
Major elective	5
General electives	10
Undergraduate thesis	4

The major elective course is chosen from the following list of courses offered at the Faculty of Mathematics and Physics:

- General Topology
- Algebraic Curves
- Introduction to Geometric Topology
- Affine and Projective Geometry
- Coding Theory and Cryptography
- Financial Mathematics 1
- Game Theory
- Mathematical Modelling
- Numerical Methods II

FRI

Interdisciplinary University Study Programme Administrative Information Systems

The study programme is offered jointly by the Faculty of Administration and the Faculty of Computer and Information Science and leads to the title “diplomirani inženir upravne informatike (UN)”, abbr. “dipl. inž. upr. inf. (UN)”.

The joint study programme is designed to provide students with knowledge in computer technologies, internet and new information technologies as well as in administration-legislation, economics and management, required for understanding public and business administration.

The first year consists of core courses in both fields with 6 ECTS of elective subjects, while the second and third year courses provide the students with a combined understanding of both study fields. The programme concludes with a diploma thesis with a work load of 16 ECTS in the last semester.

FIRST YEAR COURSES:

Title	ECTS
Introduction to Programming	6
Theory of Public Administration	8
Basic Economics	7
Theory of Organisation	7
Fundamentals of Probability and Statistics	6
Informatics	8
Programming and Algorithms	6
Database Basics	6
General electives	6

SECOND YEAR COURSES:

Title	ECTS
Methods and Techniques for Decision-Making Process Support in Public Administration	4
Computer Communication	6
Introduction to Artificial Intelligence	6
Legislative Regulation of Public Administration	6
Human Resource Management in Public Administration	7
Business Process Informatisation in Public Administration	7
Data management technologies	6
Web Programming	6
Elective subjects	12

THIRD YEAR COURSES:

Title	ECTS
Communication and Project management	6
Planning and Governance	6
Information Systems Development	6
Administrative Procedure and Judicial Review of Administrative Acts	8
Information Systems in Public Administration	6
Management in the Public Sector	6
E-business	6
Diploma Thesis	16

FRI

Master Study Programme Computer and Information Science

The programme leads to the degree “magister inženir računalništva in informatike”, abbr. “mag. inž. rač”.

The first year consists of 4 mandatory courses including mathematics and core-curriculum topics in computer and information science, 4 major elective courses and 12 ECTS of general elective courses. In the second year, students choose 6 additional major elective courses, while a work load of 24 ECTS is devoted to the preparation of the master thesis. All mandatory and major elective courses have a workload 6 ECTS. The general elective courses can be chosen from appropriate courses offered by the Faculty or within other 2nd cycle programmes at the University of Ljubljana.

FIRST YEAR COURSES

Title	ECTS
Mathematics II	6
Programming	6
Major elective	6
Major elective	6
General elective	6
Algorithms	6
Computer Systems	6
Major elective	6
Major elective	6
General elective	6

SECOND YEAR COURSES

Title	ECTS
Major elective	6
Major elective	6
Major elective	6
Major elective	6
Major elective	6
Major elective	6
Master Thesis	24

MAJOR ELECTIVE COURSES

Title	ECTS
Artificial Intelligence	6
Wireless Sensors Networks	6
Unconventional Computing	6
Perception in Cognitive Systems	6
Biomedical Signal and Image Processing	6
Advanced Software Development Methods	6
Digital Signal Processing	6
Computability and Computational Complexity	6
E Learning	6
Machine Learning	6
Introduction to Bioinformatics	6
Information Security and Privacy	6
Numerical Mathematics	6
Computer Sound Production	6
Soft and Natural Computing Algorithms	6
Data Mining	6
IT Governance	6
Information and Interaction Design	6
Cryptography and Computer Security	6
Exploiting Processors' Performance	6
Computer Forensics	6
Contemporary Approaches in Information Systems Development	6
Discrete Mathematics	6
Management of Production and Service Processes	6
Cloud Computing	6
Computational Topology	6
Topical research themes I	6
Topical research themes II	6

FRI

Master Study Programme Computer Science and Mathematics

The programme leads to the degree “magister inženir računalništva in matematike”, abbr. “mag. inž. rač. mat.”

The first year consists of 2 mandatory and 2 elective courses in computer science, 5 elective courses in mathematics, and a total of 11 ECTS for general elective course. The second year consists of only elective courses: 4 in mathematics, 3 in computer science and 1 in either mathematics or computer science. In addition, a work load of 17 ECTS is given to the preparation of the master thesis which is distributed throughout the spring semester of the second year. Among the mathematics elective courses, the students are required to choose 4 out of group A and 5 out of group B in the list of courses.

FIRST YEAR COURSES

Title	ECTS
Major elective in mathematics	5
Major elective in mathematics	5
Major elective in mathematics	5
Major elective in computer science	6
Major elective in computer science	6
General elective	3
Algorithms	6
Computer Systems	6
Major elective in mathematics	5
Major elective in mathematics	5
General elective	8

SECOND YEAR COURSES

Title	ECTS
Major elective in mathematics	5
Major elective in mathematics	5
Major elective in computer science	6
Major elective in computer science	6
Major elective in mathematics	5
Major elective in mathematics	5
Major elective in computer science	6
Major elective in mathematics or computer science	5
Master Thesis	17

MAJOR ELECTIVE COURSES IN COMPUTER SCIENCE

Title	ECTS
Artificial Intelligence	6
Perception in Cognitive Systems	6
Advanced Software Development Methods	6
Digital Signal Processing	6
Computability and Computational Complexity	6
Machine Learning	6
Introduction to Bioinformatics	6
Soft and Natural Computing Algorithms	6
Data Mining	6
Information and Interaction Design	6
Contemporary Approaches in Information Systems Development	6
Theory of Programming Languages	6

MAJOR ELECTIVE COURSES IN MATHEMATICS, GROUP A

Title	ECTS
Logic in Computer Science	5
Computer Aided Geometric Design	5
Computational Geometry	5
Coding Theory and Cryptography	5
Probability Methods in Computer Science	5

MAJOR ELECTIVE COURSES IN MATHEMATICS, GROUP B

Title	ECTS
Data Analysis and Visualization	5
Selected Topics in Computational Mathematics	5
Selected Topics in Numerical Analysis	5
Selected Topics in Game Theory	5
Mathematics by Computer	5
Symbolic Computation	5
Graph Theory	5
Selected Topics in Discrete Mathematics	5
Combinatorics 2	5
Optimization Methods 2	5
Cryptography and Security	5

Doctoral Programmes

FRI

The Faculty of Computer and Information Science offers or participates in the following third cycle programmes leading towards the degree Doctor of Sciences.

- Computer and Information Science
- Interdisciplinary doctoral programme Biosciences, offered jointly with the Biotechnical Faculty, Faculty of Electrical Engineering and the Faculty of Mechanical Engineering
- Humanistic and Social Sciences, offered jointly with the Faculty of Arts, and the Faculty of Social Sciences.

DOCTORAL PROGRAMME IN COMPUTER AND INFORMATION SCIENCE

The doctoral programme Computer and Information Science is designed to deepen the candidate's knowledge of computer science and information technology, while also providing training in soft skills for research and development. We recommend it both to students who intend to pursue careers in academia and to students who intend to carry out demanding and innovative development in the computing industry.

The entire courseware, lectures and exams are in English. The span of the doctoral programme is three years and the total workload is 180 ECTS.

1st year

The first study year is composed of the qualifying exam, research work, 12 ECTS of general electives either from the Faculty's catalogue of offered courses or suitable courses from other 3rd cycle programmes at the University of Ljubljana, two intensive courses in computer science chosen from the Faculty's offered selection, Research Skills I, Research Skills II, Seminar I and Seminar II.

2nd year

In the second year, the candidate takes part in Seminar III and Seminar IV, but primarily focuses on research which is guided by the candidate's mentor and on which candidate closely collaborates with the chosen laboratory. To advance to the third year the candidate must have an approved thesis topic which includes giving a written description and a defense.

3rd year

The third year is reserved for research and preparation of the doctoral thesis, which the candidate will present within Seminar V.

Year 1	Overview course	Elective course from CS	Elective course		Scientific Skills I	Seminar I
	Elective course from CS	Elective course	Research work		Scientific Skills II	Seminar II
Year 2	Research work					Seminar III
						Seminar IV
Year 3	PhD dissertation preparation					Seminar V
5 ECTS		5 ECTS	5 ECTS	5 ECTS	5 ECTS	5 ECTS

The doctoral programme is comprised of

- three mandatory courses with 6 ECTS each
- two elective courses from computer and information science with 6 ECTS each
- elective courses from either computer and information science or other courses offered at the University of Ljubljana or other universities amounting to 10 ECTS
- five seminars with a total of 138 ECTS

REQUIRED COURSES

The purpose of the Overview course is to verify whether the PhD student has a sufficient background in computer science and informatics, as covered by selected undergraduate courses and included in the standard US Graduate Record Examination Subject Test for Computer Science. The other two required courses are Scientific Skills I and Scientific Skills II, with topics like paper writing, writing project proposals, preparing good oral and poster presentation, copyright and patent laws, ethics in science and similar.

ELECTIVE COURSES

The candidate chooses two of six available elective courses from the list.

- Architectures and Algorithms
- Artificial Intelligence
- Computer Systems
- Informatics
- Selected Topics from Software Development
- Mathematical Methods in Computer Sciences

The other two elective courses can be chosen from the above list or from other doctoral study programmes at the University of Ljubljana or other universities with combined workload of at least 10 ECTS.

SEMINARS

There are five seminars, one in each of the first five semesters of the study programme. At these seminars the students present their work (e.g. papers, project proposals, posters, theses) to each other and to their mentors.

Research

Research activities (as well as most Undergraduate, Master, and Doctoral theses research) at the Faculty of Computer and Information Science are performed in twenty research laboratories that are organized into six chairs. The main sources of research funding are the Slovenian Research Agency, the Ministry of Education, Science and Sport, the Ministry of Defence, European Union programmes (COST, 6th and 7th Framework Programme), EU structural funds, industry partners, and various bilateral programmes including those in USA, France, Austria, Norway, Portugal, Greece, the UK, Czech Republic, Poland, Bosnia and Herzegovina, the Republic of Serbia and Montenegro. The Ministry of Education, Science and Sport, together with the Slovenian Research Agency also supports the majority of postgraduate students by means of individual scholarships.

Many application projects are financed by Slovenian and European companies. In 2013, Faculty had project collaborations with the following companies: Akrapovič, Alpineon, Astec, AstraZeneca, CubeSensors, Celtra, CHS, ComTrade, CosyLab, Epilog, Globtel, IBM, Informatika, Infotehna, Inova IT, Iskra Sistemi, IskraTel, JOC, Kopa, Mega M, Microsoft, NIL, Optilab, Oracle, Slovenske železnice, SmartCom, SRC, Studio Moderna, Špica, Telekom Slovenije, TMG-BMC, Turboinštitut, UCS, Vieste, XLAB, Zemanta and others.

Besides being at the forefront of basic computer science, software engineering, information systems and information technology, our researchers are active in a number of fields of potential interest to partners from industry and government, such as

- Microcomputer systems,
- GRID technologies and parallel processing,
- Cloud and HPC computing,
- Fuzzy and neuro-fuzzy controllers,
- 3D design, visualization and animation, video editing,
- Process informatics and programmable technologies,
- Short SIMD processing,
- Intelligent RFID systems,
- Cryptography, security, privacy, digital identity management, intrusion detection,
- Digital libraries and multimedia information retrieval,
- E-learning environments,
- Numerical simulations of physical phenomena,
- Prototyping of transaction-intensive systems,
- Design of people-focused software development methodologies based on best practices,
- Service oriented architecture-based system integration,
- Fraud detection from transaction data,
- Data mining, machine learning, data visualization,
- Data analytics and Big Data,
- Mobile robotics, applications of artificial intelligence in robotics,
- Computer vision, visual cognitive systems,

- Biometry, human face detection and recognition,
- Object recognition and tracking in video streams, visual surveillance and forensic,
- Medical diagnosis and prognosis,
- Biomedical informatics, and
- Biomedical computer systems and imaging.

More information on individual laboratories and current projects is provided at the Faculty's web pages at <http://www.fri.uni-lj.si/en>.

Laboratory for Computer Graphics and Multimedia

Head:
Assistant Professor
Matija Marolt, PhD

Phone: (+386 1) 47 68 + ext.
www: www.fri.uni-lj.si/en/lgm

Staff	E-mail	Ext.
Assistant Professor Matija Marolt, PhD	matija.marolt@fri.uni-lj.si	483
Lecturer Marko Privošnik, PhD	marko.privosnik@fri.uni-lj.si	483
Lecturer Alenka Kavčič, PhD	alenka.kavcic@fri.uni-lj.si	483
Assistant Ciril Bohak, MSc	ciril.bohak@fri.uni-lj.si	483
Researcher Jernej Južna	jernej.juzna@fri.uni-lj.si	483
PhD Student-Assistant Matevž Pesek	matevz.pesek@fri.uni-lj.si	483
PhD Student Daniel Kuhl	daniel.kuhl@lgm.fri.uni-lj.si	483
Retired Professor Saša Divjak, PhD	sasa.divjak@fri.uni-lj.si	750

RESEARCH ACTIVITIES

Laboratory for Computer Graphics and Multimedia is involved in activities related to multimedia technologies, computer-based education and learning, human-computer interaction, multi-touch technologies, and virtual/augmented reality. The main ongoing activities in the laboratory are dedicated to researches in the following areas:

- multimedia information retrieval and digital libraries,
- human computer interaction,
- computer graphics,
- alternative ways for developing the educational content,
- e-learning environments and virtual laboratories.

Additionally, we are also active in the development of visualizations, virtual and augmented reality applications, interactive learning systems, and didactic simulations and visualization of natural phenomena.

In the past, members of the laboratory cooperated with other research groups in the development of military training systems, medical imaging applications, simulation tools for computer supported industrial automation, including robotized environments, and computer supported quality control and management systems. The laboratory was also a member of the international consortium CoLoS, which was active in the area of computer supported conceptual learning of natural sciences.

EQUIPMENT

The laboratory is well equipped with professional software tools for 3D design, visualization, animation, and video editing. Some presentation and videoconferencing equipment is also available. The laboratory has also built a multi-touch table, which is used for developing and testing alternative ways of human computer interaction. To support the alternative and natural user interface research, the laboratory has some Kinect and LeapMotion depth sensors, as well as 3D mouse and multi-monitor system.

INVITED TALKS AND LECTURES

Matevž Pesek: Creativity in technics, 11. 10. 2013, an invited talk at Market of ideas: Are you also creative? as part of How are you? Project, Ljubljana, Slovenia.

Matija Marolt: Music Information Retrieval, 9. 12. 2013, an invited talk at Faculty of Arts, University of Ljubljana, Ljubljana, Slovenia.

SELECTED PUBLICATIONS

A. Kavčič, M. Pesek, C. Bohak, M. Marolt. Web portal for teacher - developer collaboration in electronic learning materials production. Education in information society: conference proceedings, 2013, pp. 92-99.

C. Bohak, M. Marolt. Kinect web kiosk framework. Human factors in computing and informatics: proceedings, LNCS 7946, 2013, Maribor, Slovenia.

M. Guid, M. Možina, C. Bohak, A. Sadikov, I. Bratko, Building an intelligent tutoring system for chess endgames. CSEDU 2013, pp. 263-266.

C. Bohak, S. Žagar, A. Sodja, P. Škrli, U. Mitrovič, F. Pernuš, M. Marolt, Neck veins: an interactive 3D visualization of head veins, Proceedings of the 4th International Conference World Usability Day Slovenia 2013, Ljubljana, Slovenia, pp. 64-66.

C. Bohak, M. Marolt, Discovering multi-level structure in folk music, Proceeding of ERK 2013, Portorož, Slovenia, pp. 149-152.

M. Pesek, M. Marolt, Chord estimation using compositional hierarchical model, MML 2013: proceedings, Prague, Czech Republic.



Multi-touch table

M. Pesek, M. Poredoš, J. Guna, E. Stojmenova, M. Marolt, Mood-dependent visual representation of audio recordings for music recommendation, Proceedings of the 4th International Conference World Usability Day Slovenia 2013, Ljubljana, Slovenia, pp. 53-55.

M. Pesek, F. Mihelič, Hidden Markov model for chord estimation using compositional hierarchical model features, Proceedings of ERK 2013, Portorož, Slovenija, pp. 145-148.

J. Južna, P. Češarek, D. Petcu, V. Stankovski, Solving solid and fluid mechanics problems in the cloud with mOSAIC, Comput. sci. eng. (Print), year. XX, vol. XX, pp. 1-22.

J. Južna, P. Češarek, V. Stankovski, Porting Existing MATLAB Applications to the Cloud using the mOSAIC Platform, Proceedings of the Third International Conference on Parallel, Distributed, Grid and Cloud Computing for Engineering 2013, Pécs, Hungary, pp. 1-15.

Laboratory for Biomedical Computer Systems and Imaging

Head:
Full Professor
Franc Jager, PhD

Phone: (+386 1) 4768 + ext.
www: <http://www.fri.uni-lj.si/en/lbcsi/description/default.html>

Staff	E-mail	Ext.
Full Professor Franc Jager, PhD	franc.jager@fri.uni-lj.si	362, 780 (247, 860)
Assistant Professor Aleš Smrdel, PhD	ales.smrdei@fri.uni-lj.si	247, 860

RESEARCH ACTIVITIES

The laboratory is involved in basic research connected to biomedical signal and imaging data. The main research goals are summarized as following:

- understanding and describing physiological phenomena, using computers in modelling and understanding of physiologic relationships, locally and remotely monitoring physiologic events, graphically displaying anatomic details and physiologic functions, visualizing and representing biomedical signal and imaging data, developing standardized databases to study physiologic mechanisms and to evaluate the performance and robustness of recognition techniques, characterizing data, establishing detection criteria and recognition techniques to automatize the analysis of bioelectric patterns to as high a degree as possible, examinations, procedures, and medical practice, in order to improve the quality and reliability of examinations, and to interpret data and results qualitatively and quantitatively,

- developing performance measures and protocols to evaluate detection techniques, developing biomedical information technologies and software.

The principal research topic currently underway is the development and evaluation of recognition algorithms for accurately detecting transient ischaemic events and classifying true ischaemic events from non-ischaemic events in biomedical signal data using the LTST DB (Long-Term ST Database) of human-expert annotated ambulatory electrocardiogram (ECG) records. The second research topic is maintaining, updating and distributing the standardized international reference-annotated ECG database LTST DB. The database is result of a multinational research effort and contains 86 24-hour ambulatory recordings with a number of human-expert annotated transient ischaemic and non-ischaemic ST events. The database is intended to serve as a reference set in evaluating the performance of ST analyzers, and as a reference set to study physiologic mechanisms responsible for ischaemia. See:

- <http://www.physionet.org/physiobank/database/lststdb/> and
- <http://www.physionet.org/challenge/2003/>.

From 2007 the database is publicly available. See also:

- <http://lbcsi.fri.uni-lj.si/lststdb/>.

The next research topic is the development of interactive graphic user interface editing tools (SEMIA – semi-automatic) to visualize, display and annotate long-term electrocardiograms. SEMIA, version 3.0.1, to view diagnostic and morphology feature-vector time series, and to examine the human annotations to the LTST DB is under GNU General Public License and is available at <http://www.physionet.org/physiobank/database/lststdb/semia/>.

Another research topic is the characterization of the temporal patterns of transient ischaemic events and time-frequency representations of diagnostic parameters in ambulatory ECG signals. The goals are to differentiate physiologic mechanisms generating ischaemia and predicting impending ischaemia.

Another important contribution of the laboratory to the world community is the interactive graphic tool EVAL_ST, used to evaluate the performance and robustness of ischaemia analysers. The tool is under GNU General Public License and is available at http://www.physionet.org/physiotools/eval_st/.

Another research topic concerns the comparison of various linear and non-linear signal processing techniques to separate uterine electromyogram (EMG) records of term and pre-term delivery groups with the final goal to predict pre-term delivery.

Another research topic is automated detection of macula in retinal images and quantitative assessment of auto fluorescence in retinal images.

The Laboratory supports a Web mirror site (<http://physionet.fri.uni-lj.si>) for a part of Europe to the PhysioNet Web site (<http://www.physionet.org>) which is located at the Massachusetts Institute of Technology in

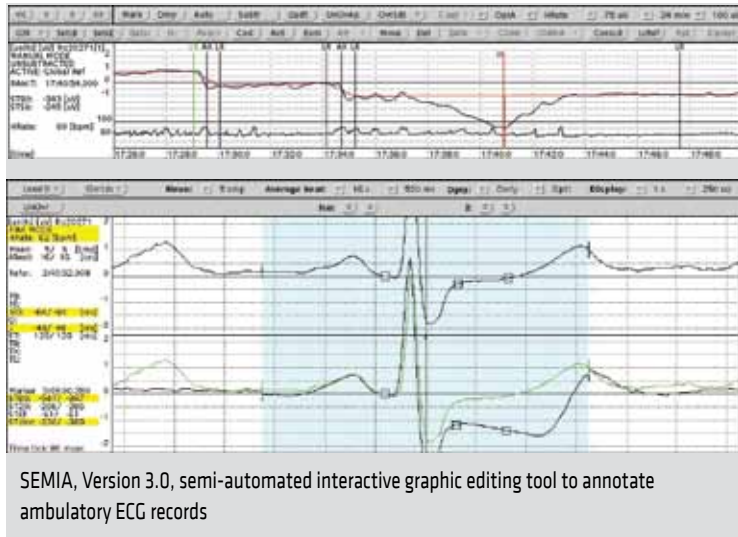

Cambridge, USA. Maintenance of the PhysioNet Web site is supported by the U.S. National Institutes of Health. PhysioNet offers free access via the Web to large collections of recorded physiologic signals and related open-source software.

EQUIPMENT

The laboratory owns two high-speed electroencephalographic recording devices to record and monitor electroencephalogram (EEG) signals and one EEG Holter recorder.

RESEARCH PROJECTS

Metabolic and inborn factors of reproductive health, birth II (P3-0124). Research Programme, Slovenian Research Agency (2009-2019).

LABORATORY GUESTS

MSc Cattleya Duangate, Sirindhorn International Institute of Technology (SIIT), Thammasat University, Thailand. 1. 10. 2012 - 31. 7. 2013. Lotus project, Doctorate exchange and degree.

RESEARCH VISITS

Franc Jager: Massachusetts Institute of Technology, Cambridge, USA, Laboratory for computational physiology, 7. 9 - 11. 9. 2013. The purpose of visit was joint work on enhancement of the Term-Preterm ElectroHysteroGram Database (TPEHG DB) (in the scope of P3-0124 research programme) which we developed and posted on PhysioNet. The database (<http://www.physionet.org/pn6/tpehgdb/>) is intended to serve as a reference set for developing automated techniques to predict pre-term birth; and on enhancement of the Long-Term ST Database

(LTST DB) with newly derived feature-vector time series of Karhunen-Loeve coefficients.

INVITED TALKS AND LECTURES

Franc Jager: Separating sets of term and pre-term uterine EMG records, 10. 9. 2013, an invited lecture at Massachusetts Institute of Technology, Cambridge, Massachusetts, USA.

SELECTED PUBLICATIONS

A. Smrdel and F. Jager. Automatic classification of long-term ambulatory ECG records according to type of ischemic heart disease. *BioMedical Engineering OnLine*, 10: 107, 2011.

A. Minchole, F. Jager and P. Laguna. Discrimination between ischemic and artifactual ST segment events in Holter recordings. *Biomedical signal processing control*, 5: 21-31, 2010.

J. Faganeli and F. Jager. Automatic classification of transient ischaemic and transient non-ischaemic heart-rate related ST segment deviation episodes in ambulatory ECG records. *Physiological Measurement*, 31: 323-337, 2010.

G. Fele-Žorž, G. Kavšek, Ž. Novak-Antolič and F. Jager. A comparison of various linear and non-linear signal processing techniques to separate uterine EMG records of term and pre-term delivery groups. *Medical & Biological Engineering & Computing*, 46(9):911-922, 2008.

A. Smrdel and F. Jager. Diurnal Changes of the Heart Rate and Sympathovagal Activity for Temporal Patterns of Transient Ischemic Episodes in 24-hour Electrocardiograms. *EURASIP, Adv. Signal. Process. 2007*, Article ID 32386, 10 pages, 2007.

F. Jager, G.B. Moody, R.G. Mark. Protocol to assess robustness of ST analysers: A case study. *Physiological Measurement*, 25:629-643, 2004.

A. Smrdel and F. Jager. Automated detection of transient ST-segment episodes in 24h electrocardiograms. *Medical & Biological Engineering & Computing*, 42:303-311, 2004.

F. Jager, A. Taddei, G.B. Moody, M. Emdin, G. Antolič, R. Dorn, A. Smrdel, C. Marchesi, R.G. Mark. Long-Term ST Database: A Reference for the Development and Evaluation of Automated Ischaemia Detectors and for the Study of the Dynamics of Myocardial Ischaemia. *Medical & Biological Engineering & Computing*, 41:172-182, 2003.

F. Jager, G.B. Moody, R.G. Mark. Detection of Transient ST-Segment Episodes During Ambulatory ECG-Monitoring. *Computers and Biomedical Research*, 31:305-322, 1998.

F. Jager. Guidelines for assessing performance of ST analysers. *Journal of Medical Engineering & Technology*, 22(1): 25-30, 1998.

Laboratory of Adaptive Systems and Parallel Processing

Head:

Associate Professor
Uroš Lotrič, PhD

Phone: (+386 1) 4768 + ext.

www: <http://www.fri.uni-lj.si/si/laboratoriji/laspp/>

Staff	E-mail	Ext.
Associate Professor Uroš Lotrič, PhD	uros.lotric@fri.uni-lj.si	874
Associate Professor Branko Šter, PhD	branko.ster@fri.uni-lj.si	783
Assistant Nejc Ilc	nejc.ilc@fri.uni-lj.si	307
PhD Student-Assistant Davor Sluga	davor.sluga@fri.uni-lj.si	875
PhD Student-Assistant Tom Vodopivec	tom.vodopivec@fri.uni-lj.si	382
Retired Professor Andrej Dobnikar, PhD	andrej.dobnikar@fri.uni-lj.si	382

RESEARCH ACTIVITIES

The main research topics include: soft computing, adaptive systems, parallel processing, information theoretic modelling, evolutionary biosynthesis, natural computing algorithms, and reinforcement learning supported by Monte Carlo methods. Within these areas we are mainly focused on problems where the lack of theoretical knowledge prevents exact solutions and the size of the problems demands a parallel processing approach or guided exploration.

The first paradigm requires learning by example and methods based on natural computing algorithms which comprise artificial neural networks, evolutionary algorithms, fuzzy logic and other biologically inspired algorithms. Current work focuses on natural based modelling of sub-cell structures with Boolean networks, and new efficient methods for data clustering.

For the second paradigm we are focusing on parallel cluster programming by using MPI and OpenMP libraries, and parallel processing within different Grid environments like Condor and Microsoft HPC Server. We are also involved in the programming of natural computing algorithms and information-theory based algorithms on graphical processors using NVidia CUDA tools and libraries.

The third paradigm comprises reinforcement learning and Monte Carlo methods. We are researching Monte Carlo Tree Search extensions to direct the exploration of sub-optimal solutions in very large state spaces.

EQUIPMENT

nVidia Tesla K20 GPU Computing Processor, Intel Xeon Phi 5110P, FPGA design boards

RESEARCH PROJECTS

Synergy of the technological systems and processes (P2-0241). Basic Research Programme (with the Faculty of Mechanical engineering, University of Ljubljana), Slovenian Research Agency (2009-2014).

RESEARCH VISITS

Branko Šter: University of Banja Luka, Faculty of electrical engineering, Bosnia and Herzegovina, 16. 1. – 15. 2. 2013. Research work.

SELECTED PUBLICATIONS

D. Olszewski, B. Šter: Asymmetric clustering using the alpha-beta divergence. Pattern recognition, 47: 2031-2041, 2013.



We organize the annual competition in mobile robotics Robo Liga FRI. Student teams from technical and science faculties compete with LEGO Mindstorms NXT sets in solving a challenging task

N. Kunstelj, D. Žnidarčič, B. Šter: Using association rules mining for sweet potato (*Ipomoea batatas* L.) in Slovenia: a case study. *International journal of food, agriculture & environment - JFAE*, 11: 253-258, 2013.

N. Kunstelj, D. Žnidarčič, B. Šter: Employing artificial neural networks and regression in analysis on knowledge about sweet potato (*Ipomoea batatas* L.) in Slovenia. *Italian journal of food science*, 25: 263-274, 2013.

B. Šter. Selective recurrent neural network: Neural processing letters, 38: 1-15, 2013.

N. Ilc, A. Dobnikar: Generation of a clustering ensemble based on a gravitational self-organizing map. *Neurocomputing* 96: 45-56, 2012.

U. Lotrič, P. Bulič: Applicability of approximate multipliers in hardware neural networks. *Neurocomputing*, 96: 57-65, 2012.

A. Dobnikar, U. Lotrič, B. Šter (ur.): Adaptive and natural computing algorithms: 10th international conference ICANNGA 2011, Ljubljana, Slovenia, April 14-16, 2011, Lecture notes in computer science, 6593, 6594, Berlin, Heidelberg, Springer, 2011.

Laboratory for Computer Architecture

Head:

Assistant Professor
Mira Trebar, PhD

Phone: +386 1 4768 + ext.

www: <http://www.fri.uni-lj.si/en/laboratories/lca/>

Staff	E-mail	Ext.
Associate Professor Patricio Bulič, PhD	patricio.bulic@fri.uni-lj.si	361
Assistant Professor Mira Trebar, PhD	mira.trebar@fri.uni-lj.si	254
Assistant Jure Bordon	jure.bordon@fri.uni-lj.si	394
PhD Student-Assistant Rok Češnovar	rok.cesnovar@fri.uni-lj.si	394
Retired Professor Veselko Guštin, PhD	veselko.gustin@fri.uni-lj.si	
Retired Professor Ljubo Pipan, PhD		

RESEARCH ACTIVITIES

Research activities cover computer architectures, software-hardware co-design, parallel processing, embedded systems, programmable logic, soft computing, radiofrequency identification (RFID), Near Field Communication (NFC).

A majority of research activities include the development of approximate arithmetic circuits for signal processing and adaptive systems. Analysis and research are oriented to the solution of approximate multiplier applicability and squarer in hardware implementation of DSP algorithms and neural networks where a shorter time delay of proposed methods and efficient implementations is more important than accuracy. Another part of work is dedicated to GPU implementation of algorithms for automatic analysis of remote sensing images.

Furthermore, the research activities also include studies and development of cold chain control and shelf life prediction by using radiofrequency identification technology (RFID) in supply chain management and wireless tracking of objects to acquire the information used in traceability



QR code used to access traceability data (RFID-F2F)

systems. For larger amount of collected data is very important to build classification and prediction models by using neural networks, support vector machines (SVMs) and some new methods applicable in design of intelligent RFID systems, or pervasive computing research oriented towards Internet of Things. Additionally, further research is oriented towards NFC mobile payment systems.

Moreover, our research activities also include the field of heterogeneous parallel computing and architectures. Currently we are focusing on the field of self-adaptive strategies for heterogeneous architectures, specifically mixed multi- and many-core systems. The self-adaptive strategies are intended for problems that have a non-constant complexity during the run-time. With these strategies we modify the execution environment (i.e. load-balancing, thread organization, merging the workloads and other auto-tuning procedures) of the application during run-time in order to meet one of the following constraints: the real-time constraint or the power consumption constraint.

RESEARCH PROJETS

Pervasive computing (P2-0359), Research Programme, Slovenian Research Agency (2009-2017).

RESEARCH VISITS

Mira Trebar: University of Cartagena, Spain, 10. 3. - 16. 3. 2013. ERASMUS Exchange - RFID and NFC technologies (Seminar given on the basis of research collaboration in EU F2F-RFID project).

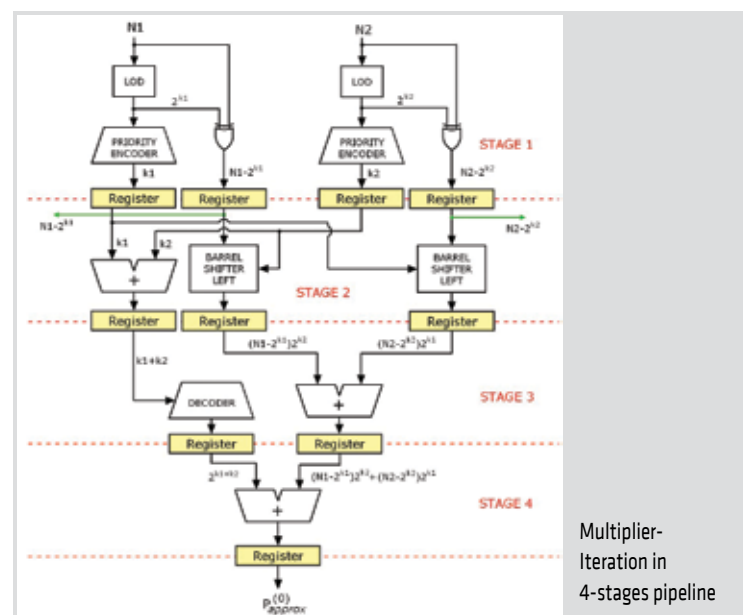

Multiplier-Iteration in 4-stages pipeline

SELECTED PUBLICATIONS

A. Avramović, Z. Babić, D. Raič, D. Strle, P. Bulić. An approximate logarithmic squaring circuit with error compensation for DSP applications. *Microelectronics Journal*, 2014, vol. 45, iss. 3, str. 263-271.

L. Qi, M. Xu, Z. Fu, M. Trebar, X. Zhang. SLDS: a WSN-based perishable food shelf-life prediction and LFSO strategy decision support system in cold chain logistics. *Food control*, 2014, vol. 38, str. 19-29.

P. Marchante, A. A. Melcon, M. Trebar, Mira, P. Filippin. Advanced traceability system in aquaculture supply chain. *Journal of food engineering*, Feb. 2014, vol. 122, str. 99-109.

P. Bulić, V. Guštin, D. Šonc, A. Štrancar. An FPGA-based integrated environment for computer architecture. *Computer applications in engineering education*, Mar. 2013, vol. 21, no. 1, str. 26-35.

R. Češnovar, V. Risojević, Z. Babić, T. Dobravec, P. Bulić. A GPU implementation of a structural-similarity-based aerial-image classification. *The journal of supercomputing*, Aug. 2013, vol. 65, no. 2, str. 978-996.

M. Trebar, M. Lotrič, I. FONDA, A. Pleteršek, K. Kovačič. RFID data loggers in fish supply chain traceability. *International journal of antennas and propagation (Online)*, 2013, str. 1-9.

P. Bulić. Fixed-point multiplication and division in the logarithmic number system : a way to low-power design = Zmanjševanje porabe v vezjih z uporabo celoštevilskega množenja in deljenja v logaritemskem številskem sistemu. *Informacije MIDEM*, ISSN 0352-9045, 2013, letn. 43, št. 4, str. 203-211.

U. Lotrič, P. Bulić. Applicability of approximate multipliers in hardware neural networks. *Neurocomputing* 96: 57-65 , 2012.

A.Parreno Merchante, A. Alvarez Melcon, M. Trebar, A. CRAH, P. Filippin. Improvement of traceability processes in the farmed fish supply chain. *LISS 2012 : proceedings of 2nd International Conferenre on Logistics, Informatics and Service Science, Beijing, China*, vol. 2, pp. 373-379, 2012.

P. Bulić, T. Dobravec. An approximate method for filtering out data dependencies with a sufficiently large distance between memory references. *Journal of Supercomputing*, vol. 56, no. 2: pp. 226-244, 2011.

AWARDS AND RECOGNITIONS

Best Product Award (CubeSensors) at the Hardware Battlefield; CES 2014, Las Vegas.

Computer Communications Laboratory

Head:
Assistant Professor
Mojca Ciglarič, PhD

Phone: (+386 1) 4768 + ext.
www: <http://www.fri.uni-lj.si/en/laboratories/ccl/>

Staff	E-mail	Ext.
Assistant Professor Mojca Ciglarič, PhD	mojca.ciglaric@fri.uni-lj.si	377
Assistant Matjaž Pančur, PhD	matjaz.pancur@fri.uni-lj.si	277
Assistant Miha Grohar, BSc	miha.grohar@fri.uni-lj.si	795

RESEARCH ACTIVITIES

The main research interests of our laboratory members are diverse: communications and communication protocols, computer networks design, distributed architectures - cloud and grid architectures, cloud security, service oriented architecture with related technologies, network security and security policies, sustainability in all ICT areas, computer supported learning systems and practical use of agile methodologies for the development of software and information systems.

In 2013, we have researched most actively the following areas:

- In the area of cloud architectures, we have researched complex virtual environments building automatization (orchestration). Such environments could be used for e-learning (virtual laboratories), software and distributed systems testing, network components etc.
- In the area of e-learning, we have improved our virtual laboratory in a cloud for teaching computer communications and other courses. The infrastructure of eleven servers was used by more than 400 students, most of them with at least three virtual machines. We are continuously improving the virtual lab and evaluating the students'



Cloud computing - physical infrastructure: servers, storage, Infinband switch

feedback. At the same time we are researching the pedagogical aspects of introducing e-learning in a cloud (e.g. Virtual Computing Lab) into the teaching process: how could we enable our students to perform complex exercises that include multiple servers, diverse network topologies and other resources 24/7, regardless of their location.

- Our research also included hybrid public-private clouds, sky computing (cloud bursting) and integration of several e-learning related systems in a cloud. Further we made a proof of concept of virtual cloud possibilities for learning cloud administration in a cloud environment.
- In the area of communication protocols, we have researched IPv4 to IPv6 transition mechanisms and routing protocols in vehicular networks. Further, we have tested identity management, authentication, authorization and remote administration protocols integration in large production environments and in cloud systems. We have also researched requirements for carrier-grade cloud architecture and its usage in large telecommunication company.
- In the area of agile methodologies, we have studied the impact of test-first programming on productivity, code complexity, tests properties (branch coverage) and the mutation score indicator.

EQUIPMENT

Besides the typical office equipment, the Computer Communications Laboratory is equipped with a few pieces of advanced networking / cloud computing hardware and software equipment. Hardware: one 20 Gb/s Infiniband DDR network switch, two 24-port and two 48-port Dell Gigabit Switches, one 24-port Arista 10Gb/s SFP Data Center Switch for testing

purposes, Dell Power Vault NAS 745 (2 TB), an IBM dual processor eServer xSeries 336 storage server with 3 TB of locally attached SCSI storage in an HP MSA-20 enclosure, one SuperMicro storage server with 12 TB of locally attached SATA storage, a private cloud consisting of 11 Dell PowerEdge QuadCore R200 servers each with four Gigabit Ethernet ports and an Infiniband SDR 10 Gb/s connection, 4 Dell PowerEdge DualCore Servers and 2 Dell PowerEdge Dual Xeon Processor servers, 2 HP Proliant Servers with 32GB of ram for testing purposes, 4 802.11b/g/n wireless Access Points, various mobile devices, ActivCard SmartCard readers and smart cards.

Software: network management tools and utilities, OpenStack private cloud, VMware virtualization tools, Nexenta and Openfiler storage appliance software, databases and development tools, Redmine project management software, Gitlab software to collaborate on code, Moinmoin Wiki, Microsoft development tools and utilities; several open-source Java development tools and utilities including Mobile Phone development utilities, ...

RESEARCH PROJECTS

EPSIAE - Green IT: Entering Sustainability within academic ICT studies. Erasmus Intensive Programme Project, European Commission (2010-2013).

KC CLASS - Cloud Assisted Services (3211-10-000467)., Structural Funds Project, EU and Ministry of education, science and sport (2011-2013).

HESUDI - Healthcare Support Using Domotics and IT. Erasmus Intensive Programme Project, European Commission (2013-2014).

Platform for Test Environments Orkestration in the Cloud. Industry-Funded Project (2013-2014).

Unified Highly Available and Robust Application Platform for Telecommunication Services. Industry-Funded Project (2013-2015).

HOME - Higher Education Online: MOOCs the European Way. Lifelong Learning Programme, European Comission (2013-2016).

LABORATORY GUESTS

Desislav Desev, University of Plovdiv "Paisii Hilendarski". 1. 4. - 30. 4. 2013., Educational cloud research.

Vladimir Jirasek, CCSK, CISSP-ISSAP & ISSMP, CISM, CISA, CRISC, UK. 24. 5. - 25. 5. 2013. Lecture: Secure your cloud applications by building solid foundations with enterprise security architecture.

Olaf Maennel, University of Loughborough, UK. 22. 12. - 23. 12. 2014. IPv4 - IPv6 transition technologies research.

Andrej Krevl, Stanford University, USA. 20. 12. 2013 - 6. 1. 2014. Software defined networking research.

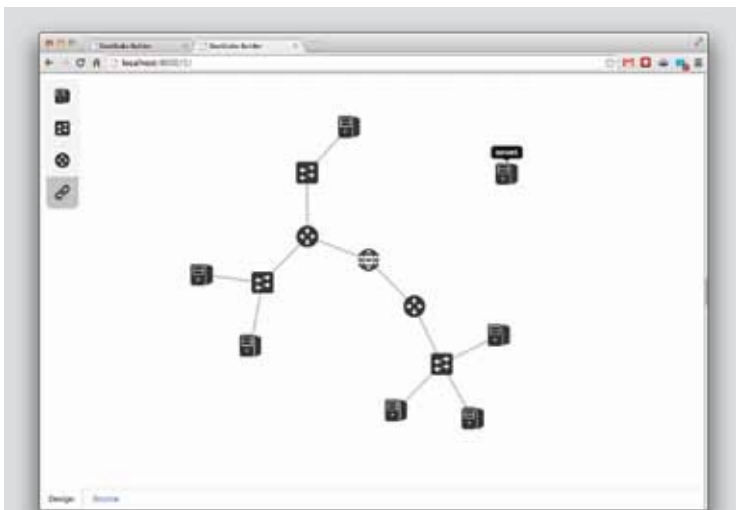

A teacher's front end for building complex virtual environment, which will be used later by students in virtual laboratory

RESEARCH VISITS

Miha Grohar: Birmingham City University, Birmingham, UK, 7. 4. 2013 – 13. 4. 2013. Research of sustainability-related contents within academic ICT studies.

INVITED TALKS AND LECTURES

Mojca Ciglarič, Matjaž Pančur: Software Defined Networking: Good or Bad for Cloud Security?, 23. 10. 2013, Cloud Security Alliance CEE Summit.

Matjaž Pančur: SDN - Software Defined Networking and Quantum, 29. 5. 2013, OpenStack CEE Day, , Budapest, Hungary.

SELECTED PUBLICATIONS

J. Porenta, M. Ciglarič. Comparing commercial IP reputation databases to open-source IP reputation algorithms. *Computer systems science and engineering*, ISSN 0267-6192, 2013, vol. 28, no. 1, str. 1-14.

N. Škoberne, O. Maennel, I. Phillips, R. Bush, J. Žorž, M. Ciglarič. IPv4 address sharing mechanism classification and tradeoff analysis. *IEEE/ACM transactions on networking*, ISSN 1063-6692, 2013, str. 1-14, doi: 10.1109/TNET.2013.2256147.

M. Matičič, T. Selič Kurinčič, A. Kastelic, M. Poljak, G. Lesničar, J. Meglič-Volkar, M. Rajter, J. Prah, Z. Balkan, M. Ciglarič, M. Pančur: A national multidisciplinary healthcare Network for Treatment of Hepatitis C in People who Inject Drugs in Slovenia: High Enrollment, Adherence and Sustained Virological Response. In: M. Soyka, M. Backmund, Suchtmedizin in Forschung und Praxis, Proc. 3rd International Symposium on Hepatitis Care in Substance Users, *Suchtmed* 15(4), pp.245, 2013.

M. Pančur, M. Ciglarič. Impact of test-driven development on productivity, code and tests: A controlled experiment, *Information and Software Technology* 53 (2011), pp. 557-573 DOI information: 10.1016/j.insof.2011.02.002.

J. Rugelj, M. Ciglarič, A. Krevl, M. Pančur, A. Brodnik. Constructivist learning environment in a cloud. In: UDEN, Lorna (ur.). *Workshop on learning technology for education in cloud (LTCE'12)*, (Advances in intelligent systems and computing, Vol. 173). New York: Springer, 2012, pp. 193-204.

N. Škoberne, M. Ciglarič. Practical Evaluation of Stateful NAT64/DNS64 Translation, *Adv. electr. comput. eng*, 2011, vol. 11, no. 3, pp. 49-54. <http://www.aece.ro/abstractplus.php?year=2011&number=3&article=8>.

M. Ciglarič, T. Lesjak, A. Krevl, A. Brodnik. Getting more from virtual laboratory : a case study. In: AUER, Michael E. (ur.), SCHREURS, Jeanne (ur.). *Academic and corporate e-learning in a global context*. Wien: International Association of Online Engineering; Kassel: University Press, cop. 2010, str. 1170-1178.

M. Ciglarič, A. Krevl, M. Jeličič, A. Brodnik. Laboratory as a service: architecture, implementation and experiences. *Asia-Pac. collab. educ. journal*, 2010, vol. 6, no. 2, str. 69-86.

M. Ciglarič, S. Mavsar. Raziskovanje omrežnih napadov: muholovec Simx. *Elektroteh. vestn.*, 2010, letn. 77, št. 4, str. 173-178.

M. Pančur, M. Ciglarič, M. Trampuš, T. Vidmar. Towards empirical evaluation of test-driven development in a university environment. V: ZAJC, Baldomir (ur.), TKALČIČ, Marko (ur.). *The IEEE Region 8 EUROCON 2003 : computer as a tool : 22-24. September 2003*, Faculty of Electrical Engineering, University of Ljubljana, Slovenia : proceedings. Piscataway: IEEE, cop. 2003, vol. 2, pp. 83-86.

Computer Structures and Systems Laboratory

Head:

Full Professor Nikolaj Zimic, PhD

Phone: (+386 1) 4768 + ext.
www: <http://www.fri.uni-lj.si/>,
<http://lrs.fri.uni-lj.si/bio/>,
<http://lrs.fri.uni-lj.si/cb/>,
<http://lrs.fri.uni-lj.si/qca/>

Staff	E-mail	Ext.
Full Professor Nikolaj Zimic, PhD	niko.zimic@fri.uni-lj.si	395
Full Professor Miha Mraz, PhD	miha.mraz@fri.uni-lj.si	372
Assistant Professor Iztok Lebar Bajec, PhD	iztok.bajec@fri.uni-lj.si	785
Assistant Miha Moškon, PhD	miha.moskon@fri.uni-lj.si	371
Assistant Primož Pečar, MSc	primoz.pecar@fri.uni-lj.si	371
Researcher Domen Šoberl, MSc	domen.soberl@fri.uni-lj.si	371
PhD Student-Assistant Mattia Petroni	mattia.petroni@fri.uni-lj.si	371
PhD Student-Assistant Jure Demšar	jure.demsar@fri.uni-lj.si	371
PhD Student-Assistant Jure Bordon	jure.bordon@fri.uni-lj.si	371
Laboratory Technician Miran Koprivec	miran.koprivec@fri.uni-lj.si	371

RESEARCH ACTIVITIES

The laboratory consists of three active groups, the Computational Biology Group, the Quantum-dot Cellular Automata Group, and the Collective Behaviour Group. Our results have been published in Nanotechnology and Animal Behaviour, the most respectable journals in their respective fields.

The Computational Biology group in cooperation with the National Institute of Chemistry of Slovenia studies synthetic biology structures used for processing in biological systems. Research is oriented towards the establishment of new modelling approaches, parameter estimation techniques, sensitivity and robustness analyses and performance evaluation. The goal is to fully automatize the design of synthetic

biological systems with predefined functionalities. We attended the iGEM 2012 student competition as mentors to the modelling part of team Slovenia. Team Slovenia received the best model prize and second absolute position among 190 teams. We are also developing new modelling methods in the field of cancer treatment with photodynamic therapy (PDT) in cooperation with R. E. Kavetsky Institute of Experimental Pathology, Oncology and Radiobiology.

The Quantum-dot Cellular Automata group is involved with studies of nano-scale devices capable of performing computation at very high switching speeds and consuming extremely small amounts of electrical power. The devices have been proposed in 1993 by Craig Lent, et al. as a physical implementation of an automaton using quantum-dot cells and combine the discrete nature of both cellular automata and quantum mechanics. Lent's automaton is intended as a binary processing platform that will eventually replace the current transistor switching circuits. The proposal quickly gained popularity and it was first fabricated in 1997. Our group with the premise that future processing platforms should not disregard the advantages of multi-valued processing extended Lent's automaton so that it supports ternary processing. Our research activities are concentrated on the general problem of planning and routing in quantum-dot cellular automata, the analysis of the ternary quantum-dot cell parameter space, but mostly with processing structures implemented using ternary quantum-dot cells.

The Collective Behaviour group uses soft computing methods to model coordinated behaviour in biological systems. Animal groups such as fish schools, insect swarms and bird flocks are frequently admired in awe as they exhibit complex coordinated behaviour. May these behaviours result from social interactions among individuals or be fruit of our pattern seeking mind we are researching soft computing algorithms that allow controlled entities to display behaviours similar to those observed in nature. Our aim is to support Biologists in forming or proving their hypotheses about why and how animal groups behave as they do. Our group developed a fuzzy logic based computer model of bird flocking which uses fuzzy logic to describe an individual's drives. Simulations performed using the model present behaviour remarkably similar to behaviours of natural flocks. Our research activities are concentrated on the extension of the model to support studies of various collective behaviours, such as: bird flocks landing and takeoff, sensory system studies, predator/prey relations, and flocking behaviour under predation.

RESEARCH PROJECTS

Pervasive computing (P2-0359). Research Programme, Slovenian Research Agency (2013-2016).

KC OPCOMM - Open Communication Platform for Service Integration (3211-10-000468). Structural Funds Project, Ministry of education, science and sport (2011-2013).

Agile Database for Tensiomyographic Measurements: Case study and Implementation, Industry-Funded Project, TMG-BMC Ltd. (2013-)

LABORATORY GUESTS

Prof. Dr. Ovid Farhi, Rector, Technical University of Varna, Varna, Bulgaria, 24. 6. – 28. 6. 2013. Visiting the Faculty and the Univeristy of Ljubljana and meeting with the dean of the Faculty.

Elena Draganova, Chief of Rectorate. Technical University of Varna, Varna, Bulgaria, 24. 6. – 28. 6. 2013. Visiting the Faculty and the Univeristy of Ljubljana and meeting with the dean of the Faculty.

Prof. Dr. Velko Naumov, Vice Rector and Head of the International office, Technical University of Varna, Varna, Bulgaria, 24. 6. – 28. 6. 2013. Visiting the Faculty and the Univeristy of Ljubljana and meeting with the dean of the Faculty.

Prof. Dr. Michael Scopchanov, Technical University of Varna, Varna, Bulgaria, 24. 6. – 28. 6. 2013. Visiting the Faculty and the Univeristy of Ljubljana and meeting with the dean of the Faculty.

Ivan Rusev, Technical University of Varna, Varna, Bulgaria, 24. 6. – 28. 6. 2013. Research visit with the presentation of TCP/SCTP Proxy Server.

Ayhan Mehmed, Technical University of Varna, Varna, Bulgaria, 24. 6. – 28. 6. 2013. Research visit with the presentation of Automatic Car Plate Recognition.

Vladislav Kovachev Technical University of Varna, Varna, Bulgaria, 24. 6. – 28. 6. 2013. Research visit with the presentation of Home Automation with Raspberry Pi and Arduino.

Vilian Petkov, Technical University of Varna, Varna, Bulgaria, 24. 6. – 28. 6. 2013. Research visit with the presentation of Software Interface Between an ERP System and Mobile Robots.

Mehmed Mehmedov, Technical University of Varna, Varna, Bulgaria, 24. 6. – 28. 6. 2013. Research visit with the presentation of 3D Mapping Using Microsoft Kinect.

RESEARCH VISITS

Miha Moškon: Institute of Systems and Synthetic Biology, University of Évry-Val-d'Essonne, France (Prof. Dr. Alfonso Jaramillo), 4. 1. - 10. 4. 2013. Establishment of mathematical model of the PACE system.

Miha Moškon: Institute of Systems and Synthetic Biology, University of Évry-Val-d'Essonne, France (Prof. Dr. Alfonso Jaramillo), 10. 5. - 25. 6. 2013. Analysis of processing capabilities of the PACE system.

Jure Demšar: Behavioural Ecology and Self-organization, Centre for Ecological and Evolutionary Studies, Faculty of Mathematics and Natural Sciences, University of Groningen, The Netherlands (Prof. Dr. Charlotte K. Hemelrijk), 23. 9. - 23. 12. 2013. Advanced predator target selection tactics in a predator-prey evolutionary model.

INVITED TALKS AND LECTURES

Miha Moškon: Analysis of fitness landscape investigation efficiency, 18. 3. 2013, an invited lecture at Institute of Systems and Synthetic Biology, University of Évry-Val-d'Essonne, France.

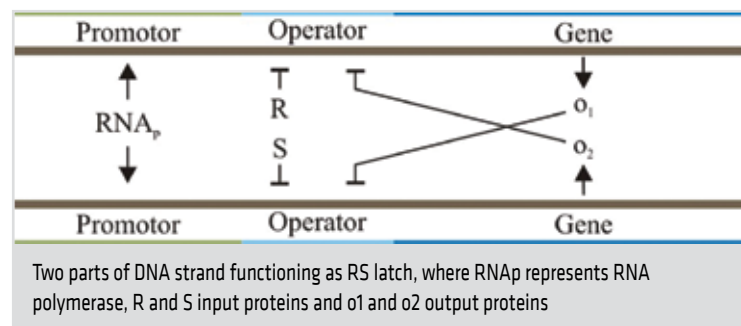

Miha Moškon: Extending the applicability of Phage-Assisted Continuous Evolution (PACE), 21. 6. 2013, an invited lecture at Institute of Systems and Synthetic Biology, University of Évry-Val-d'Essonne, France.

Jure Demšar: Evolutionary models of collective behaviour, 8.10.2013, an invited lecture at Centre for Ecological and Evolutionary Studies, University of Groningen, The Netherlands.

Jure Demšar: Evolving «intelligent» predators, 19.12.2013, an invited lecture at Centre for Ecological and Evolutionary Studies, University of Groningen, The Netherlands.

SELECTED PUBLICATIONS

M. Moškon, M. Mraz, Systematic approach to computational design of gene regulatory networks with information processing capabilities, IEEE/ACM transactions on computational biology and bioinformatics, 2013 (accepted for publication), p.1-11.

M. Moškon, Š. Novak, M. Medeot, I. Lebar Bajec, N. Zimic, M. Mraz. Solving the logistic problems with optimal resource assignment using fuzzy logic methods, Journal of Advanced Transportation, June 2013, vol.47, no.4, p.447-460.

M. Stražar, M. Mraz, N. Zimic, M. Moškon, An adaptive genetic algorithm for parameter estimation of biological oscillator models to achieve target quantitative system response, Natural computing, 2013 (accepted for publication), p.1-9.

I. Lebar Bajec, P. Pečar. Two-layer synchronized ternary quantum-dot cellular automata wire crossings. Nanoscale research letters. Apr. 2012, vol. 7, p. 1-12.

M. Moškon, M. Mraz. Modelling and analysing the information processing capabilities of simple biological systems. Math. model. anal. , Sep. 2012, vol. 17, no. 4, p. 467-484.

M. Janež, P. Pečar, M. Mraz. Layout design of manufacturable quantum-dot cellular automata. Microelectron. j., Jul. 2012, vol. 43, no. 7, p. 501-513.

I. Lebar Bajec, F.H. Heppner. Organized flight in birds, Animal behaviour, 78(4): 777-789, 2009.

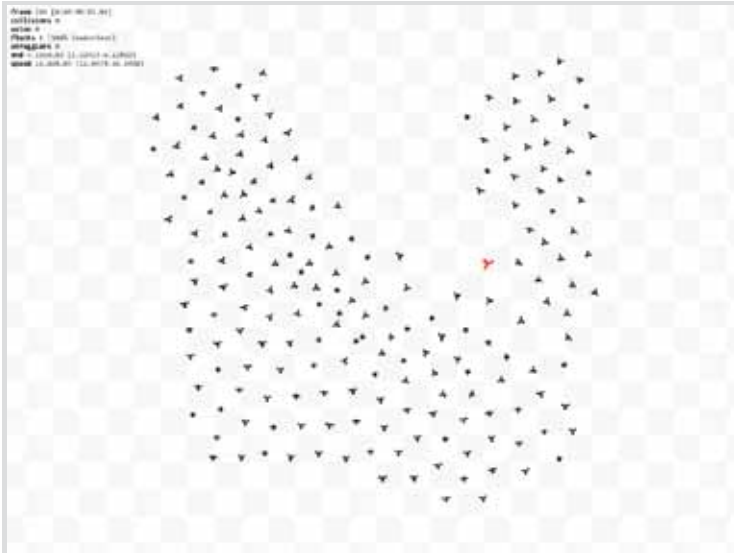

A frame from synflocks, our fuzzy logic based bird behavior simulator, using which we are currently investigating predator/prey relations, more precisely the interplay of flocking behavior and various predation strategies

P. Pečar, A. Ramšak, N. Zimic, M. Mraz, I. Lebar Bajec. Adiabatic pipelining: a key to ternary computing with quantum dots. *Nanotechnology*, 19(49): 1-12, 2008

P. Pečar, M. Mraz, N. Zimic, M. Janež, I. Lebar Bajec. Solving the ternary quantum-dot cellular automata logic gate problem by means of adiabatic switching. *Jpn. j. appl. phys.*, 47(6): 5000-5006, 2008.

I. Lebar Bajec and M. Mraz. Multi-valued logic based on quantum-dot cellular automata. *International Journal of Unconventional Computing*, 3(4):311-322, 2007.

A. Jazbec, M. Mraz, I. Lebar Bajec, N. Zimic. Towards automated cooking process. *Food Research International*, 40(6):733-741, 2007.

I. Lebar Bajec, N. Zimic and M. Mraz. The ternary quantum-dot cell and ternary logic. *Nanotechnology* 17(8):1937-1942, 2006.

I. Lebar Bajec, N. Zimic and M. Mraz. Towards the bottom-up concept: extended quantum-dot cellular automata. *Microelectronic Engineering*, 83(4-9): 1826-1829, 2006.

N. Zimic and M. Mraz. Decomposition of a Complex Fuzzy Controller for the Truck&Trailer Reverse Parking Problem. *Mathematical and Computer Modelling*, 43(5-6):632-645, 2006.

I. Lebar Bajec, N. Zimic and M. Mraz. Simulating flocks on the wing: the fuzzy approach. *Journal of Theoretical Biology*, 233(2): 199-220, 2005.

Information Systems Laboratory

Head:

Associate Professor
Marjan Krisper, PhD
/ Assistant Professor
Rok Rupnik, PhD
(from 1 October
2013)

Phone: (+386 1) 4768 + ext.

www: <http://www.fri.uni-lj.si/en/laboratories/infolab/>

Staff	E-mail	Ext.
Assistant Professor Rok Rupnik, PhD	rok.rupnik@fri.uni-lj.si	814
Associate Professor Marjan Krisper, PhD	marjan.krisper@fri.uni-lj.si	388
Assistant Professor Damjan Vavpotič, PhD	damjan.vavpotic@fri.uni-lj.si	367
Assistant Professor Ana Saša Bastinos, PhD	ana.sasa@fri.uni-lj.si	198
Assistant Professor Tomaž Hovelja, PhD	tomaz.hovelja@fri.uni-lj.si	367
Researcher Cyprian Laskowski, PhD	cyprian.laskowski@fri.uni-lj.si	198
Young Researcher Marina Trkman, BSc	marina.trkman@fri.uni-lj.si	198
Young Researcher Simon Vrhovec, BSc	simon.vrhovec@fri.uni-lj.si	367
Laboratory Technician Alenka Rožanec, PhD	alenka.rozanec@fri.uni-lj.si	198
Retired Professor Miran Mihelčič, PhD		

RESEARCH ACTIVITIES

The Information Systems Laboratory is involved in basic and applied research in the field of Information Systems. The following primary areas of research are currently being pursued:

Software Development Methodologies (SDM). Based on the *collaborative practice research* we strive to define the methodology and supporting tools for designing new or adapting existing SDMs. Specifically, we focus on the methodologically socio-technical suitability to both organization and project-specific requirements. From this topic two PhD theses have been developed. An approach for reengineering methodologies (Agile methodology framework) and supporting tools (Agile Methodology

Toolset - AMT, see figure below) present the most important results of this research. We applied the approach in several Slovenian software companies like Marand, RCC-IRC Celje, Datalab, Comland, IPMIT, Adacta, ZZI. We have also developed a Unified methodology for information systems development – EMRIS for Government Centre for Informatics. We also developed a model of resistance to change that evaluates the economic risks of using specific parts of information systems. The model was applied in NLB and is currently being applied in Paediatric clinic of University Medical Centre Ljubljana.

IT/IS Strategy Planning and Enterprise Architecture. Strategy planning is one of the research areas that have been traditionally present in the Information systems laboratory since its existence. In the period between 2004 and 2008 we published several methodologies that focus on how to build strategic plans for information systems. In the last edition we integrated an enterprise architecture framework, which enables the design of strategic enterprise architecture during plan development. These methodologies are based on many years of practical experiences in developing strategic plans for a wide range of organizations. We developed strategic plans for the following organizations: the Employment Service of Slovenia, KAD (financial institution), Elektro Ljubljana (electricity distribution operator), ELES (Slovenian electric power transmission company), Slovenian electricity distribution operators association, Informatika, d.d., Mobitel (Slovenian mobile telephony operator), government institutions, Elektro Celje (electricity distribution operator), Dravske elektrarne Maribor (Drava power plants) and Slovenske železnice (Slovenian national railway company). Recently, we also developed enterprise architectures, organized and executed workshops for Iskratel (telephony and networks solutions developer) and Employment Service of Slovenia. In the context of IT/IS planning we focus our research on: enterprise architecture, IS/IT architectures, information systems reengineering, business process reengineering, electronic business, COBIT and other IT governance standards.

Contemporary approaches to software development. In collaboration with software companies we do research on the maturity level of the new approaches to software development. Recently we have been focusing on: “Model-driven development”, “Business-rule approach”, and “Method engineering”.

Mobile business and mobile applications. We explore different mobile applications models focusing on the research of the context-awareness and context-aware mobile application model. The results have been presented as the Methodology for developing mobile applications. Furthermore we developed a context-server that is able to connect with Process Control Systems. On the basis of contextual data (NFC, location, the role of employee, business rules, characteristics of the production process, the current state of equipment, logistics characteristics, etc.) the context server prepares the relevant data for the given situation and delivers to the mobile device employed in the proper context.

We are currently involved in a European project AgrolIT which deals with increasing the efficiency of farming through on open standards

platform. The overall objective of the project is to set-up and pilot AgrolIT platform to be tested in different parts of Europe (Denmark, Poland, FYR of Macedonia and Romania). AgrolIT platform will integrate key applications and services that will address the challenges presented above. More specifically the project will select mobile applications for inclusion in AgrolIT user interface for simple and efficient input of data during farmers' daily activities (into database of ERP system of farms). Integrate services and applications for wireless data collection from sensors, monitoring systems and other devices into the platform. Provide advanced decision support for farming through implementation of decision support system and cloud based. Integrate all of the above into a working AgrolIT platform, based on open standards (enabling the inclusion of additional applications and services after the end of the project thus achieving sustainability of the platform) and pilot test it. AgrolIT project brings together partner experts from farming consultancy, software industry, agriculture and HEI. Additionally, this problematic is also being pursued in the context of project Mobilne aplikacije v kmetijstvu (Mobile applications in farming).

Data Mining applications and Decision Support Systems. Our areas of interest are innovative approaches for decision support. We combine research in this area with research in the area of mobile applications and as result we do research on mobile decision support. We have also developed data mining decision support system based on Oracle Data Mining API and Engine. In the area of applied research we have created several strategic reports on different models of introduction of data mining to information systems.

IT governance. We actively analyse IT processes in different organizations. IT process analyses are performed with regard to COBIT model and ITIL standards. We also analyse the efficiency of the informatics in the organizations and their business information architectures.

SOA – Service Oriented Architecture. Service-Oriented Architecture (SOA) is a collection of loosely-coupled, distributed services which communicate and interoperate via agreed standards. A service is a mechanism to enable access to one or more capabilities, where said access is provided using a prescribed interface and is exercised consistently with constraints and policies as specified by the service description. Services are independent and can run on different platforms. In this area we do research on how SOA focuses on business processes and how the information technology should support these processes with its main motivation to increase the capability of an organization to address new business requirements in the short term by reusing existing business logic and data models, thus incurring only minimal cost, resource, and time overheads, while minimizing risks, especially when compared to rewriting entire application systems. From this topic one PhD thesis is being developed. Due to difficulties with complex systems which have become very demanding from the point of view of integration and maintenance, it has become the prevalent paradigm for information systems development. We developed IS reengineering and the development of SOA based enterprise architecture for Slovenian electricity distribution operators association.

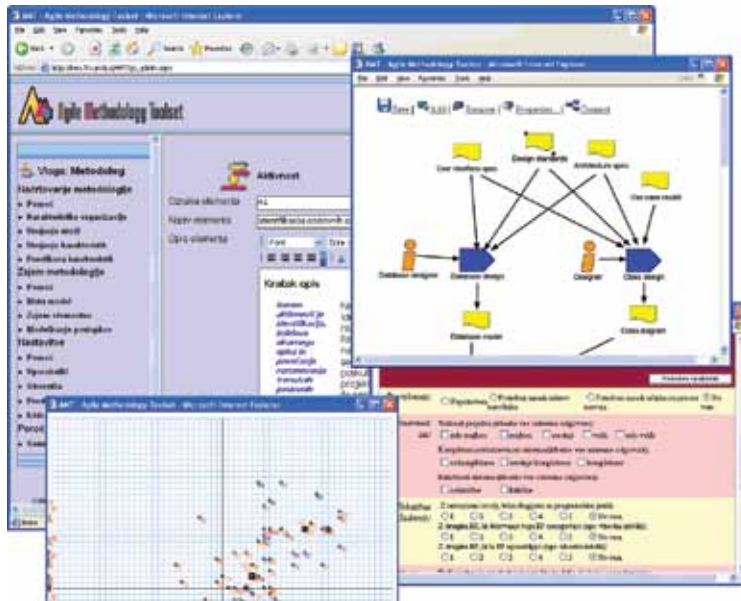

Screenshot of the AMT system

RESEARCH PROJECTS

MAK – Mobile applications in farming. Structural Funds Project, Ministry of education, science and sport (2012-2014).

e-DKES – expert dynamic human resource decision support system. Structural Funds Project, Ministry of education, science and sport (2012-2014).

KC CLASS - Cloud Assisted Services (3211-10-000467). Structural Funds Project, Ministry of education, science and sport (2011-2013).

KC OPCOMM - Open Communication Platform for Service Integration (3211-10-000468). Structural Funds Project, Ministry of education, science and sport (2011-2013).

Pervasive computing (P2-0359). Research Programme, Slovenian Research Agency (2013-2016).

SELECTED PUBLICATIONS

S. Vrhovec, M. Trkman, A. Kumer, M. Krisper, D. Vavpotič. Outsourcing as an economic development tool in transition economies: scattered global software development. *Information technology for development*, ISSN 0268-1102, 2014

M. Trkman, P. Trkman. Actors misaligned interests to explain the low impact of an information system : a case study. *International journal of information management*, ISSN 0268-4012. [Print ed.], 2014, in press.

D. Vavpotič, B. Žvanut, I. Trobec. A comparative evaluation of E-learning and traditional pedagogical process elements. *Educational technology & society*, ISSN 1436-4522, 2013, vol. 16, no. 3, str. 76-87

A. Pivk, O. Vasilecas, D. Kalibatiene, R. Rupnik. On approach for the implementation of data mining to business process optimisation in

commercial companies. *Technological and economic development of economy*, ISSN 2029-4913. [Print ed.], June 2013, vol. 19, no. 2, str. 237-256.

T. Hovelja, O. Vasilecas, R. Rupnik. A model of Influences of Environmental Stakeholders on Strategic Information Systems Planning Success in an Enterprise. *Technological and Economic Development of Economy*, 2013, vol. 19, no. 3, str. 465-488.

A. Šaša, M. Krisper. Multi-criteria decision making in ontologies. *Information sciences*, ISSN 0020-0255. [Print ed.], Feb. 2013, vol. 222, str. 593-610

V. Mahnič, T. Hovelja. On using planning poker for estimating user stories. *Journal of Systems and Software*, vol. 85, no. 9, pp. 2086-2095, 2012.

D. Vavpotič, O. Vasilecas. Selecting a methodology for business information systems development: decision model and tool support. *Comput. Sci. Inf. Syst.*, vol. 9, no. 1, Jan. 2012

D. Vavpotič, T. Hovelja. Improving the evaluation of software development methodology adoption and its impact on enterprise performance. *Comput. Sci. Inf. Syst.*, vol. 9, no. 1., Jan 2012.

A. Šaša, M. Krisper. Multi-criteria decision making in ontologies. *Information sciences*, 2012, In press.

O. Vasilecas, R. Dubauskaitė, R. Rupnik. Consistency checking of UML business model. *Technol. econ. dev. econ. (Spausd.)*, vol. 17, no. 1, pp. 133-150, 2011.

D. Vavpotič, O. Vasilecas. An approach for assessment of software development methodologies suitability. *Elektron. elektrotech.*, vol. 114, no. 8, pp. 107-110, 2011.

A. Šaša, M. Krisper. Ontology-based knowledge management in service-oriented systems. *J. inf. organ. sci.*, vol. 35, no. 1, pp. 105-118, 2011.

A. Šaša, M. Krisper. Service-oriented architectural framework for support and automation of collaboration tasks. *J. inf. organ. sci.*, vol. 35, no. 1, pp. 119-133, 2011.

A. Šaša, M. Krisper. Enterprise architecture patterns for business process support analysis. *J. syst. softw.*, 2011, vol. 84, no. 9, str. 1480-1506, 2011.

D. Lavbič, O. Vasilecas and R. Rupnik. Ontology-based multi-agent system to support business users and management. *Technological and economic development of economy*, vol. 16, no. 2, pp. 327-347, 2010.

D. Lavbič, I. Lajovic and M. Krisper. Facilitating information system development with Panoramic view on data. *Computer Science and Information Systems*, vol.4, no.7, pp. 737-767, 2010.

D. Lavbič and M. Krisper. Facilitating Ontology Development with Continuous Evaluation. *Informatica*, vol. 21, No. 4, pp. 533-552, 2010.

M. Trkman and P. Trkman. A wiki as intranet: a critical analysis using the Delone and McLean model. *Online inf. rev.*, vol. 33, no. 6, pp. 1087-1102, 2010.

D. Vavpotič, M. Bajec. An approach for concurrent evaluation of technical and social aspects of software development methodologies. *Information and software technology*, vol. 51, no. 2, pp. 528-545, 2009.

Sasa, Ana; Juric, Matjaz; Krisper, Marjan: Service-Oriented Framework for Human Task Support and Automation, *IEEE Transactions on Industrial Informatics*, vol. 4(4), 2008.

Laboratory of e-media

Head:
Full Professor Denis
Trček, PhD

Phone: (+386 1) 476 8 + ext.
www: <http://www.fri.uni-lj.si/en/laboratories/lem/>

Staff	E-mail	Ext.
Full Professor Denis Trček, PhD	denis.trcek@fri.uni-lj.si	918
Assistant Iztok Starc, MSc	iztok.starc@fri.uni-lj.si	259
Researcher David Jelenc, BSc	david.jelenc@fri.uni-lj.si	259
Young Researcher Jernej Kos, BSc	jernej.kos@fri.uni-lj.si	921
PhD Student-Assistant Damjan Tratnik	damjan.tratnik@fri.uni-lj.si	921

RESEARCH ACTIVITIES

The Laboratory of e-media is actively involved in research areas of security, privacy and trust management with an emphasis on cryptographic protocols, formal methods, security infrastructure systems like PKI and AAA. In addition, the laboratory's research activities cover quantitative modelling of human factor, aimed at the development of solutions that support decision making for the management of information systems and critical infrastructures. The foundations for these activities are methodologies like system dynamics and quantitative assessment dynamics (QAD).

Results include patented cryptographic protocols that provide security in environments with limited system resources like smart cards and RFIDs. In addition, we are developing simulation models to support the management of information systems security, and technological solutions for trust management in global networks. Furthermore, our research results have been published in renowned international journals (like those published by Elsevier and IEEE), and in monographs published by Springer, Francis & Taylor (chapter contribution) and IGI Global (chapter contribution).

Finally, laboratory members are (or have been) nominated to serve on board of important EU and international organizations (e.g., MB of ENISA, ISC NATO Panel). They also serve as reviewers for renowned

publishers (of scientific journals and monographs), they are examiners and jury members for PhDs at other EU universities, and lecturers at other universities and international events.

EQUIPMENT

Advanced body area sensor network equipment.

RESEARCH PROJECTS

Pervasive computing (P2-0359), Research Programme, Slovenian Research Agency (2009-2017).

SALUS - Security And Interoperability in Next Generation PPDR Communication InfrastructureS, European Project (Framework Programmes) (2013-2016).

COST IC0906 - Wireless Networked Moving Objects. International Project. (2010-1014).

RESEARCH VISITS

Jernej Kos: Middlesex University, London, September - October 2013. Experimental evaluation of a Sybil-tolerant compact routing protocol.

SELECTED PUBLICATIONS

TRČEK, Denis. Lightweight protocols and privacy for all-in-silicon objects. *Ad hoc networks*, ISSN 1570-8705, July 2013, vol. 11, no. 5, pp. 1619-1628.

TRČEK, Denis, BRODNIK, Andrej. Hard and soft security provisioning for computationally weak pervasive computing systems in e-health. *IEEE wireless communications*, ISSN 1536-1284. [Print ed.], Aug. 2013, vol. 20, no. 4, pp. 1-8.

JELENC, David, TRČEK, Denis. Qualitative trust model with a configurable method to aggregate ordinal data. *Autonomous agents and multi-agent systems*, ISSN 1387-2532, 2013, pp. 1-31.

JELENC, David, HERMOSO, Ramón, SABATER-MIR, Jordi, TRČEK, Denis. Decision making matters: a better way to evaluate trust models. *Knowledge-based systems*, ISSN 0950-7051. [Print ed.], Nov. 2013, vol. 52, pp. 147-164.

TRČEK, Denis. An integrative architecture for a sensor-supported trust management system. *Sensors*, Aug. 2012, vol. 12, no. 8, pp. 1-14.

TRČEK, Denis. Security metrics foundations for computer security. *Comput. j.*, 2010, vol. 53, no. 5, pp. 1106-1112, doi: 10.1093/comjnl/bxp094.

TRČEK, Denis. A formal apparatus for modeling trust in computing environments. *Math. comput. model.*, 2008, pp. 1-8, doi: 10.1016/j.mcm.2008.05.005.

TRČEK, Denis, ABIE, Habtamu, SKOMEDAL, Åsmund, STARC, Izток. Advanced framework for digital forensic technologies and procedures. *J Forensic Sci*, 2010, pp. 1-10, doi: 10.1111/j.1556-4029.2010.01528.x.

TRČEK, Denis, JÄPINNEN, Pekka. RFID security. V: ZHANG, Yan (ur.), YANG,

Laurence Tianruo (ed.), CHEN, Jiming (ed.). RFID and sensor networks : architectures, protocols, security, and integrations. (Wireless networks and mobile communications). Boca Raton: Taylor & Francis, 2010, pp. 147-168.

HERNANTES, Josune, TORRES, Jose M., LAUGE, Ana, SARRIEGI, Jose M., STARC, Iztok, ZUPANČIČ, Eva, TRČEK, Denis. Using GMB methodology on a large crisis model, FRENCH, Simon (ed.), TOMASZEWSKI, Brian (ed.), ZOBEL, Christopher (ed.). Defining crisis management 3.0 : proceedings, 2010, pp. 1-5.

TRČEK, Denis. Managing communications in critical infrastructures protection. Proc.of the ICCEA 2010, 2010. Vol. 1. Los Alamitos (California); Washington: IEEE Computer Society, cop. 2010, pp. 11-15.

Laboratory for Data Technologies

Head:

Associate Professor
Marko Bajec, PhD

Phone: (+386 1) 4768 + ext.
www: <http://lpt.fri.uni-lj.si/>

Staff	E-mail	Ext.
Associate Professor Marko Bajec, PhD	marko.bajec@fri.uni-lj.si	814
Senior Lecturer Aljaž Zrnc, PhD	aljaz.zrnc@fri.uni-lj.si	186
Assistant Professor Dejan Lavbič, PhD	dejan.lavbic@fri.uni-lj.si	186
Assistant Lovro Šubelj, PhD	lovro.subelj@fri.uni-lj.si	186
Assistant Aleš Kumer, BSc	ales.kumer@fri.uni-lj.si	186
Researcher Milan Pevec	milan.pevec@fri.uni-lj.si	186
Young Researcher Neli Blagus, BSc	neli.blagus@fri.uni-lj.si	186
Young Researcher Marko Jankovič, BSc	marko.jankovic@fri.uni-lj.si	186
Young Researcher Gregor Weiss, BSc	gregor.weiss@fri.uni-lj.si	186
Young Researcher Slavko Žitnik, BSc	slavko.zitnik@fri.uni-lj.si	186
Laboratory Technician Miha Radej, BSc	miha.radej@fri.uni-lj.si	781
Researcher Stefan Furlan, PhD	stefan.furlan@fri.uni-lj.si	

RESEARCH ACTIVITIES

The Data Technology Laboratory was founded in 2009 and is one among the youngest laboratories at the Faculty for Computer and Information Science. Its members are involved in basic and applied research in the fields of data analysis, data representation, data visualization, semantic web and method engineering:

Data analysis: is a very broad research area. We focus on the segments of business rules management systems, business intelligence, fraud management and (social) networks. Research is divided between academic research and applicative research. Applicative research is closely connected to the fields of fraud management and transaction intensive information systems architectures.

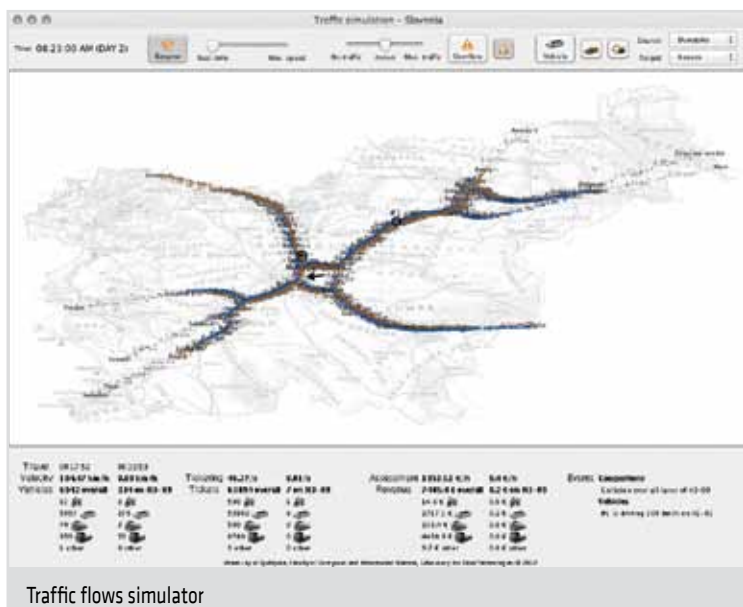

Data representation: Data entities are typically represented in an ordinary flat form. However such representation is not adequate when we are interested in relations between entities or in patterns in these relations. In that case one must employ some enhanced representation of data-like networks. Networks are the most natural representation of any relational domain (hyper pages, social networks etc.) allowing formulation of complex relations between entities. They allow the analysis of entities in the context of related entities and not in complete isolation. Networks are currently one of the hot topics in many research areas (network analysis, data mining, bioinformatics, etc.). Our research is mainly focused on analysis and mining of networks' data and using networks for fraud detection in different fields.

Data visualization: As the volume and complexity of data increases it becomes very difficult for users to effectively explore large-scale datasets. A possible solution for this problem is visualization (graphical representation of data). Visualizing large amounts of data allows us to see patterns that may otherwise remain hidden and it allows us also to quickly grasp and process large amounts of data that would otherwise require a lot of time to study. Visualizations are used in many fields (medicine, education, geo-visualizations, data-mining, financial data analysis etc.) and employ different visualization techniques (graphs, cluster diagrams, volume rendering etc.), but just any arbitrary visualization may not be inherently useful and may even lead to flawed conclusions. An important aspect of visualization is also dynamics of representation and interactivity (e.g. dynamical adjustment of mapping in real-time).

Semantic web: The current version of the World Wide Web consists of several mutually connected documents that are presented to human users by computers. These documents originated in interconnected systems where every user could contribute. This also results in the fact

that information quality cannot always be guaranteed. The current World Wide Web consists of data, information and knowledge, but the role of computers at this stage is only to deliver and represent the content of the documents that describe knowledge. To integrate different information resources users have to manually interpret these data. Semantic Web tends to improve current World Wide Web with computers processing, interpreting, integrating data on the web and with this approach aiding human users in discovering complex knowledge. Semantic Web is focused towards sharing and reusing of data and not documents. The research area emphasizes the establishment of a common framework to enable the sharing and reusing of data among applications and enterprises.

Method Engineering (ME): We are mainly focusing on situational method engineering (SME), which focuses on construction of methods by selecting appropriate method components from method-base which are later on tailored and integrated in a newly created development method for a specific situation. In the last two decades, a number of SME approaches have been proposed, but their application in practice is rare due to many reasons. With all that reasons in mind, we are now trying to develop innovative approaches that will simplify the use of SME principles by only marginal user involvement. On the other hand we are also interested in capturing new evidences, from real cases, about software development practice (e.g. what are organizations' base methods, what are developers and other project members doing on projects, what are reasons for declinations from base methods, how to keep base methods up-to date with knowledge gained from former projects, etc.).

RESEARCH PROJECTS

Information technologies and approaches for the development of highly flexible and scalable applications. Industry-Funded Project, *Iskra Sistemi d.d.* (2013).

Uniform highly available and robust application platform for telecommunications services. Industry-Funded Project, *Iskratel d.d.* (2013-2014).

Research on the development, usage and application of TellMeMore and WhoKnowsWho methods. Industry-Funded Project, *Optilab d.o.o.* (2013-2014).

TellMeMore and WhoKnowsWho: Development of a Prototype System. Industry-Funded Project, *Optilab d.o.o.* (2011-2013).

KC CLASS - Cloud Assisted Services (3211-10-000467). Structural Funds Project, Ministry of education, science, culture and sport (2011-2013).

KC OPCOMM - Open Communication Platform for Service Integration (3211-10-000468). Structural Funds Project, Ministry of education, science, culture and sport (2011-2013).

Intelligent data acquisition with ontology support (BI-R5/12-13-038). Bilateral Collaboration Project, Slovenian Research Agency (2012 - 2013).

LABORATORY GUESTS

Dr. Veljko Milutinovic, Professor at the University of Belgrade, Fellow of the IEEE, a member of Academia Europaea. Cooperation on the bilateral project BI-RS/12-13-038.

Dr. Dalibor Fiala, Assistant professor at University of West Bohemia, Czech Republic, 7. 7. – 14. 7. 2013, Collaboration on the development of algorithms for bibliometrics.

RESEARCH VISITS

Marko Bajec: Electro-technical faculty, University of Belgrade, November 2012 – February 2013. Visit related to the joint research project “Intelligent data acquisition with ontology support”.

INVITED TALKS AND LECTURES

Marko Bajec: Intelligent Agile Method Framework, 4. 6. 2013, an invited lecture at the University of Klagenfurt, Klagenfurt.

SELECTED PUBLICATIONS

L. Šubelj, M. Bajec, N. Blagus (2013). Group extraction for real-world networks: The case of communities, modules, and hubs and spokes, Proceedings of International Conference on Network Science (NetSci <13>), pp. 152-153, COBISS:9902420.

N. Blagus, M. Bajec, L. Šubelj (2013). Preserving properties under simplification of real-world networks, Proceedings of International Conference on Network Science (NetSci <13>), pp. 166, COBISS:9906004.

L. Šubelj, M. Bajec (2013). Model of complex networks based on citation dynamics, Proceedings of WWW Workshop on Large Scale Network Analysis (LSNA <13>), pp. 527-530, e-print arXiv:1303.5857, COBISS:9867604.

S. Žitnik, L. Šubelj, D. Lavbič, O. Vasilecas, M. Bajec (2013). General context-aware data matching and merging framework, Informatica 24(1), 119-152, COBISS:9735764.

N. Blagus, L. Šubelj, M. Bajec. Preserving properties under simplification of real-world networks. V: International School and Conference on Network Science, Copenhagen, June 3-7 2013. NetSci. [S. l.: s. n.], 2013, str. [166]. [COBISS.SI-ID 9906004]

G. Khodabandelou, C. Hug, R. Deneckère, C. Salinesi, M. Bajec, E. Kornysheva, M. Janković. COTS products to trace method enactment: review and selection. V: 21st European Conference on Information Systems, June 5-8, 2013, Utrecht. ECIS 2013 proceedings. Utrecht: [s. n.], 2013, str. 1-12. <http://www.staff.science.uu.nl/~Vlaan107/ecis/files/ECIS2013-0385-paper.pdf>. [COBISS.SI-ID 9920340]

D. Lavbič, S. Žitnik, L. Šubelj, A. Kumer, A. Zrnc, M. Bajec. Traversal and relations discovery among business entities and people using semantic web technologies and trust management. V: CAPLINSKAS, Albertas (ur.), et al. Databases and information systems VII: selected papers from the

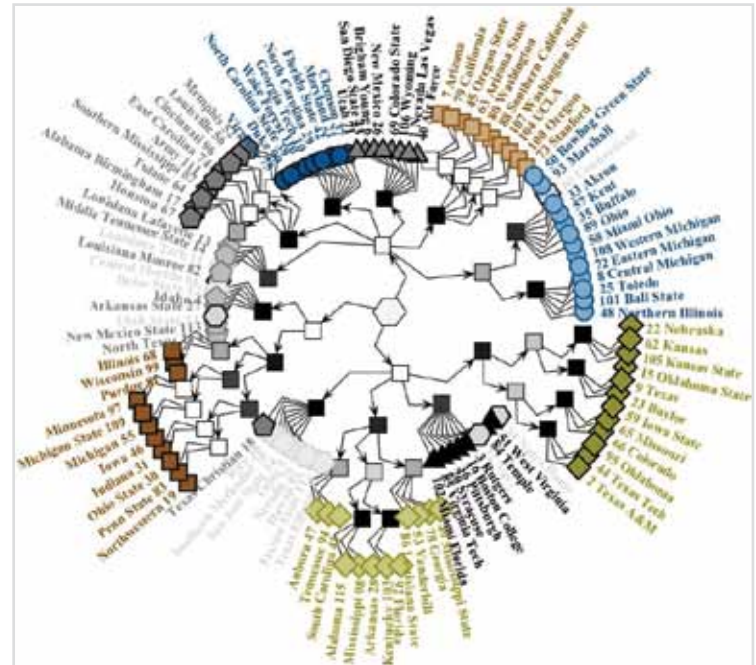

Network group hierarchy

Tenth International Baltic Conference, DB&IS 2012, (Frontiers in artificial intelligence and applications, ISSN 0922-6389, vol. 249). Amsterdam [etc.]: IOS Press, cop. 2013, str. 164-174

L. Šubelj, M. Bajec (2012). Ubiquitousness of link-density and link-pattern communities in real-world networks, European Physical Journal B 85(1), 32, doi:10.1140/epjb/e2011-20448-7, e-print arXiv:1104.3162, COBISS:8926292.

L. Šubelj, M. Bajec. Robust network community detection using balanced propagation. European Physical Journal B, 81(3), 353-362.

L. Šubelj, M. Bajec (2011). Community structure of complex software systems: Analysis and applications. Physica A: Statistical Mechanics and its Applications, 390(16), 2968-2975.

L. Šubelj, M. Bajec (2011). Unfolding communities in large complex networks: Combining defensive and offensive label propagation for core extraction. Physical Review E, 83(3), 036103.

L. Šubelj, Š. Furlan, M. Bajec (2011). An expert system for detecting automobile insurance fraud using social network analysis. Expert Systems with Applications, 38(1), 1039-1052.

N. Blagus, L. Šubelj, M. Bajec. Self-similar scaling of density in complex real-world networks. Physica, A. [Print ed.], 2012, vol. 391, no. 8, str. 2794-2802, ilustr. <http://www.sciencedirect.com/science/article/pii/S0378437111009915>. [COBISS.SI-ID 8930132]

B. Žvanut, M. Bajec. A tool for IT process construction. In: Information and software technology. Apr. 2010, vol. 52, no. 4, pp. 397-410.

D. Vavpotic, M. Bajec. An approach for concurrent evaluation of technical and social aspects of software development methodologies. In: Information and software technology, Vol. 51, no. 2, pp. 528-545, 2009.

M. Bajec, M. Krisper. A methodology and tool support for business rule management in organisations. In: Information Systems, 30(2005): 423-443, 2005.

PATENTS

L. Šubelj, S. Žitnik, D. Lavbič, Kumer A., M. Bajec. Combining heterogeneous data sources of data processing devices: application number P201300263, 2013–9–13. Ljubljana: Slovenian Institute of Intellectual Property, 2013. In process.

L. Šubelj, M. Bajec. The process for allocation of computational resources in networks of distributed devices: application number P201300392, 2013–11–20. Ljubljana: Slovenian Institute of Intellectual Property, 2013.

AWARDS AND RECOGNITIONS

2013: Marko Bajec received “IS Award for Ongoing Work”, Information Society 2013, multi conference.

2013: Lovro Šubelj, Štefan Furlan and Marko Bajec received “Recognition for outstanding research results in 2011 - for the paper *“An expert system for detecting automobile insurance fraud using social network analysis”*”.

2013: Marko Janković and Marko Bajec received a “Best paper award” for the paper *“Semi-automatic improvement of software development methods”*, IEEE Conference on Research Challenges in Information Sciences (RCIS 2013).

2013: Slavko Žitnik, Marinka Žitnik, Blaž Zupan and Marko Bajec took first place in the “BioNLP Shared Task challenge - Identification of gene transactions. ACL 2013 Conference - “Extracting Gene Regulation Networks Using Linear-Chain Conditional Random Fields and Rules”.

Laboratory for Integration of Information Systems

Head:

Full Professor Matjaž Branko Jurič, PhD

Phone: (+386 1) 4768 + ext.

www: <http://www.fri.uni-lj.si/si/laboratoriji/liis/>

Staff	E-mail	Ext.
Full Professor Matjaž Branko Jurič, PhD	matjaz.juric@fri.uni-lj.si	791
Assistant Rok Povše	rok.povse@fri.uni-lj.si	794
Researcher Aleš Frece, PhD	ales.frece@fri.uni-lj.si	792
Researcher Eva Zupančič	eva.zupancic@fri.uni-lj.si	794
Researcher Jernej Zorko	jerne.j.zorko@fri.uni-lj.si	792
Researcher Andrej Kocbek	andrej.kocbek@fri.uni-lj.si	792
Researcher Pece Adžievski	pece.adzievski@cloud.si	792
Researcher Borche Paspalovski	borce.paspalovski@cloud.si	792
Researcher Gregor Srdič	gregor.srdic@fri.uni-lj.si	792
Researcher Robert Dukarič	robert.dukaric@fri.uni-lj.si	792
Researcher Matija Cankar	matija.cankar@fri.uni-lj.si	792
Researcher Andraž Kohne	andraz.kohne@fri.uni-lj.si	792
Researcher Bojan Blažica	bojan.blazica@fri.uni-lj.si	792
Researcher Boris Cergol	boris.cergol@fri.uni-lj.si	792
Researcher Katja Cetinski	katja.cetinski@fri.uni-lj.si	794
Young Researcher Miha Nagelj	miha.nagelj@fri.uni-lj.si	794
Young Researcher Marcel Krizevnik	marcel.krizevnik@fri.uni-lj.si	794
Young Researcher Martin Potočnik	martin.potocnik@fri.uni-lj.si	794
Young Researcher Matej Hertiš	matej.hertis@fri.uni-lj.si	794

RESEARCH ACTIVITIES

Laboratory for Integration of Information Systems has been focusing on the research and development in the field of integration and interoperability of information systems, architectures and platforms. Integration and interoperability is an important topic and covers all aspects of software



and information systems development. Laboratory for Integration of Information Systems focuses specifically on software platforms, particularly Java Enterprise Edition and .NET, Service Oriented Architectures (SOA) and Cloud Computing (with focus on IaaS/PaaS/SaaS).

SOA is a set of principles and methodologies for designing and developing software in the form of interoperable services. We research technologies which enable execution, configuration and adaption of business processes in wider and comprehensive scenarios. Cloud Computing represents technologies that provide computation, software, data access, and storage services via the internet. It enables to address new areas and to develop innovative software solutions, IT services, and efficient cost-effective usage of information resources. This technology provides significant progress in the economy, government and academic circles, particularly in the field of competitiveness, business optimization and innovation. Our laboratory conducts research, development and mentoring for the development of complex Java EE and BPM/SOA solutions, e-services and e-content, and Cloud Computing solutions. This allows to address new areas and to find innovative solutions.

In collaboration with important partners such as Oracle, IBM, and Microsoft we are working on many projects that incorporate following research fields and technologies:

- Integration and interoperability methods of information systems,
- Cloud computing (IaaS, PaaS, SaaS):
 - Infrastructure as a Service
 - Platform as a Service
 - Software as a Service
- Business Process Management (BPM):
 - Modelling business processes
 - Executing business processes
 - Integrated BPM/SOA life cycle
 - Service design based on the concept of service science
- Client side web development
- Modern multitier architectures
- Java Enterprise Edition, Java EE and .NET platforms
- Architectural and technological aspects of integration and interoperability

- Middleware
- Integration platform technologies
- Service platforms and Web services
- Application and Process Servers

RESEARCH PROJECTS

KC CLASS - Cloud Assisted Services (3211-10-000467), Structural Funds Project, Ministry of education, science and sport (2011-2013).

KC OPCOMM - Open Communication Platform for Service Integration (3211-10-000468). Structural Funds Project, Ministry of education, science and sport (2011-2013).

SINTESIS - E-service and mobile application for classification, evaluation, integration, migration and security of SaaS applications. Structural Funds Project, Ministry of education, culture and sport (2012 - 2013).

R&D and Knowledge Transfer Collaboration. Industry Funded Project, Akrapovic d.d., (2013).

Process-aware Information Systems Research and Development. Industry Funded Project, Informatika d.d. (2010-2013).

IBM WAS Migration Principles and Best Practices. Industry Funded Project, Ministry of Justice., (2013).

EKT2 Reference Architecture. Industry Funded Project, Ministry of Public Administration (2013).

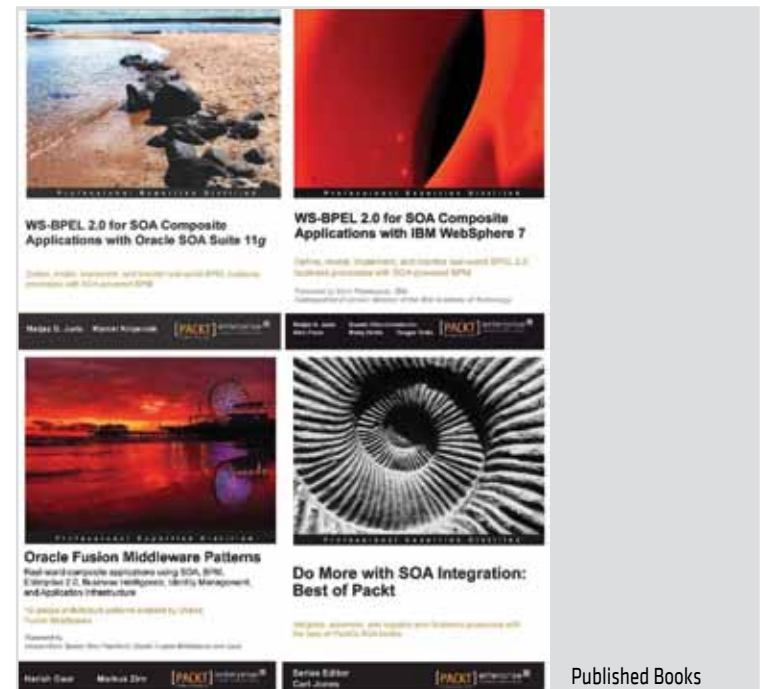

Information System Architecture and Java, BPM/SOA and Integration R&D. Industry Funded Project, Poštna banka Slovenije, d.d. (2013). R&D Collaboration and Knowledge Transfer. Industry Funded Project, SRC d.o.o., (2013).

Architectural Design, Development and Governance. Industry Funded Project, Telekom Slovenije d.d. (2013).

RESEARCH VISITS

Robert Dukarić: Visiting (PhD) Researcher, Cloud Computing and Distributed System (CLOUD) Laboratory, University of Melbourne, Australia, 1. 6. - 4. 9. 2013.

INVITED TALKS AND LECTURES

Matjaž B. Jurič: BPM/SOA governance: a practical approach, HrOUG konferencija, Crveni otok, Rovinj, 2013.

Rok Povše, Matjaž B. Jurič: Experiences with open-source BPM/SOA-based stack using Java EE, 18. HrOUG konferencija, Crveni otok, Rovinj, 2013.

Robert Dukarić, Matjaž B. Jurič: Razvoj Java aplikacija u Amazon AWS cloud: praktična demonstracija, 18. HrOUG konferencija, Crveni otok, Rovinj, 2013.

Matjaž B. Jurič: Kako vzpostaviti vodenje BPM/SOA arhitekture? = BPM/SOA governance. 18. Strokovno srečanje SIOUG in JavaSi, 2013.

Rok Povše, Matjaž B. Jurič, Zvone Gazvoda: Sintesis: platform for SaaS classification, evaluation, integration, migration and backup. Class conference 2013, Bled Slovenia.

SELECTED PUBLICATIONS

A. Frece, M.B. Jurič. Complete and reusable description of message structural constraints in web service interfaces. *Computer Standards and Interfaces*, 35(2): 218-230, 2013.

M. Potočnik, M.B. Jurič. Towards complex event aware services as part of SOA. *IEEE Transactions on Services Computing*, pp. 1-14, 2013.

J. Laznik, M.B. Jurič. Context aware exception handling in business process execution language. *Information and Software Technology*, 55(10): 1751-1766, 2013.

G. Srdić, M.B. Jurič. Model for integrated monitoring of BPEL business processes. *International Journal of Cooperative Information Systems*, 22(2): 1-29, 2013.

R. Dukarić, M.B. Jurič. A taxonomy and survey of infrastructure-as-a-service systems. *Lecture notes on information theory*. 1(1): 29-33. 2013.

M.B. Jurič, E. Zupančič: SOA governance model, Active citizenship by knowledge management & innovation : proceedings of the Management, Knowledge and Learning International Conference 2013, 19-21 June 2013, Zadar, Croatia, (MakeLearn, ISSN 2232-3309). Bangkok; Celje; Lublin: ToKnowPress, 2013, str. 905-911

M. Križevnik, M.B. Jurič. Data-bound variables for WS-BPEL executable processes. *Computer Languages, Systems and Structures*, 38(4):279-299, 2012.

R. Dukarić, M.B. Jurič. Towards a unified taxonomy and architecture of cloud frameworks. *Future Generation Computer Systems*, pp. 1-29, 2012.

B. Brumen, M. Hölbl, K. Harej, T. Welzer-Družovec, M. Heričko, M.B. Jurič, H. Jaakkola. Learning process termination criteria. *Informatika (Vilnius)*, 23(3):1-16, 2012.

A. Frece, M.B. Jurič. Modelling functional requirements for configurable content- and context- aware dynamic service selection in business process models. *Journal of Vis. Lang. and Comp.*, 23(4):223-247, 2012.

PATENTS

R. Dukarić, M.B. Jurič. Compensation Management in Cloud Computing Orchestration Devices, Patent Pending, 2013.

AWARDS AND RECOGNITIONS

M.B. Jurič was awarded University of Ljubljana »Golden Plaque« for extraordinary achievements in the development of scientific research.

Certificates: Java Champion, IBM Champion, Oracle ACE Director, Certified IBM SOA Solution Designer, Certified SOA Associate, Oracle Service Oriented Architecture Infrastructure Implementation Certified Expert, Certified IBM SOA Associate, Certified IBM Solution Advisor for Cloud Computing, Certified IBM SOA Associate, Certified IBM SOA Associate, IBM Certified Solution Architect - Cloud Computing Infrastructure.

Laboratory for Algorithms and Data Structures

Head:
Full Professor
Borut Robič, PhD

Phone: (+386 1) 4768 + ext.
www: <http://www.fri.uni-lj.si/en/laboratories/lalg/>

Staff	E-mail	Ext.
Full Professor Borut Robič, PhD	borut.robic@fri.uni-lj.si	867
Assistant Professor Tomaž Dobravec, PhD	tomaz.dobravec@fri.uni-lj.si	364
Assistant Professor Boštjan Slivnik, PhD	bostjan.slivnik@fri.uni-lj.si	363
Assistant Jurij Mihelič, PhD	jurij.mihelic@fri.uni-lj.si	819
Assistant Uroš Čibej, PhD	uros.cibej@fri.uni-lj.si	837
Retired Professor Boštjan Vilfan, PhD	bostjanv@alum.mit.edu	391

RESEARCH ACTIVITIES

Staff members perform research in the areas of approximation and randomized algorithms, algorithms for problems in combinatorial optimization (routing, covering, and location problems, flexibility in optimization problems), parallel computation (mapping and scheduling, algorithms in parallel systems), grid computing (data replication on Data Grids, P2P-based distributed search), compiler design (parsing methods and attribute grammars), linear algebra (matrix multiplication), and operating systems design. As of 2006, the Laboratory is a member of the PlanetLab, an open platform for developing, deploying, and accessing planetary-scale services.

RESEARCH PROJECTS

Parallel and Distributed Systems (P2-0095). Research Programme, jointly with Jozef Stefan Institute and Faculty of Electrical Engineering, University of Ljubljana. Slovenian Research Agency (2009-2016).

RESEARCH VISITS

Jurij Mihelič: Max Planck Institute for Informatics, Saarbrücken, Germany, 5. 8. - 9. 8. 2013. 14th Max Planck Advanced Course on the Foundations of Computer Science: Fixed-Parameter Tractability and Exact Algorithms.

SELECTED PUBLICATIONS

M. Bezenšek, B. Robič. A survey of parallel and distributed algorithms for the Steiner tree. *International Journal of Parallel Programming*, 42(2):239-264, 2013.

M. Cankar, M. Artač, M. Šterk, U. Lotrič and B. Slivnik. Co-allocation with collective requests in grid systems. *Journal for Universal Computer Science*. 19(3):282-300, 2013.

R. Češnovar, V. Risojevič, Z. Babič, T. Dobravec, P. Bulič. A GPU implementation of a structural-similarity-based aerial-image classification. *The Journal of Supercomputing*, 65(2):978-996, 2013.

U. Čibej, J. Mihelič. Search strategies for subgraph isomorphism algorithms. V: *First International Conference on Applied Algorithms*, Kolkata, India, January 13-14, 2014, (Lecture Notes in Computer Science).

J. Mihelič, T. Dobravec. SicSim : a simulator of the educational SIC/XE computer for a system-software course. *Computer Applications in Engineering Education*, doi: 10.1002/cae.21585, 2013.

I. Rožanc, B. Slivnik. Using reverse engineering to construct the platform independent model of a web application for student information systems. *Computer Science and Information Systems*, 10(4):1557-1583, 2013.

B. Slivnik. LLLR parsing. *Proc. of the 28th annual ACM Symposium on Applied Computing SAC-2013*, pp. 1698-1699, Coimbra, Portugal, 2013.

W. Stallings, J. Mihelič, B. Klemenc, P. Peer. *Koncepti operacijskih sistemov z Linuxovo lupino in programiranjem v Bashu*. Pearson 2013.

Laboratory for Architecture and Signal Processing

Head:

Full Professor Dušan
M. Kodek, PhD /
Assistant Professor
Boštjan Slivnik, PhD
(acting, 1 October 2013
- 15 January 2014)

Phone: (+386 1) 4768 + ext.
www: <http://www.fri.uni-lj.si/en/laboratories/lasp>

Staff	E-mail	Ext.
Senior Lecturer Robert Rozman, PhD	robert.rozman@fri.uni-lj.si	788
Assistant Andrej Štrancar, PhD	andrej.strancar@fri.uni-lj.si	788
Assistant Damjan Šonc, PhD	damjan.sonc@fri.uni-lj.si	788
Assistant Andraž Božiček, MSc	andraz.bozicek@fri.uni-lj.si	374
Laboratory Technician Zvonimir Petkovšek	zvonimir.petkovsek@fi.uni-lj.si	374
Full Professor Dušan M. Kodek, PhD	duke@fri.uni-lj.si	392
Retired Lecturer Igor Škraba, MSc	igor.skraba@fri.uni-lj.si	308

RESEARCH ACTIVITIES

The Laboratory for Architecture and Signal Processing is dedicated to research, undergraduate, and postgraduate education in computer architecture and digital signal processing. The laboratory is engaged in national and international research projects that include development projects for the industry. The following areas of research are currently being pursued:

1. In Computer Architecture: Design and development of special-purpose computers, both hardware and software. Comparative studies of superscalar and VLIW processors. DSP processor design and architecture. Cache replacement and coherence preservation strategies. Input/output architectures. Integrated entertainment and automation systems for “smart home” houses.

2. In Digital Signal Processing: Design and development of algorithms, hardware and software. Complexity of integer minimax approximation problem. Theoretical aspects and performance bounds for finite wordlength digital filters. In particular, bounds for minimax integer polynomial approximation over collections of non-overlapping intervals are

investigated. A general purpose finite wordlength FIR design programme was developed during the course of this work. Various applications of DSP processors are studied and implemented. Among them is a low-cost DSP processor based spectrum and vibration analyser that is now in production.

3. In Speech Processing: Speech recognition over telephone lines. Trainable high quality speech synthesis. Considerable experience from collaboration in the COST-232 European project has been acquired. The laboratory contributed to the collection of the European multi-English database. In the framework of a project with the Slovenian Telekom one of the first real-time systems for speaker-independent recognition of Slovenian digits and control words over the telephone has been developed. A national database of 780 speakers from all across Slovenia has been collected. A new technique that uses asymmetrical window functions for feature extraction and dynamically adjusted window length was tested and implemented.

RESEARCH PROJECTS

Parallel and Distributed Systems (P2-0095). Research Programme, jointly with Jozef Stefan Institute and Faculty of Electrical Engineering, University of Ljubljana. Slovenian Research Agency (2009-2016).

RESEARCH VISITS

Dušan M. Kodek: Department of Computer Science, Princeton University, USA, 2. 4. - 11. 4. 2013. Collaboration on development of bounds for uniform integer polynomial approximation.

SELECTED PUBLICATIONS

D. M. Kodek. Length limit of optimal finite wordlength FIR filters. Digital signal processing, vol. 23, no. 5, pp. 1798-1805, September 2013.

P. Bulič, V. Guštin, D. Šonc, A. Štrancar. An FPGA-based integrated environment for computer architecture. Computer applications in engineering education, vol. 21, no. 1, str. 26-35, March 2013.

D. M. Kodek. LLL algorithm and the optimal finite wordlength FIR design. *IEEE Transactions on Signal Processing*, vol. 60, no. 3, pp. 1493-1498, March 2012.

A. Božiček. Finite wordlength linear-phase FIR filter design using Babai's algorithm. Signal processing, vol. 6, no. 5, str. 146-152, 2012.

D. Stanjko, P. Beer, M. Lešnik, V. Jejčič, M. Lakota, A. Štrancar, M. Hočevar, J. Rakun, Programmable ultrasonic sensing system for targeted spraying in orchards. Sensors, vol. 12, no. 11, pp. 15500-15519, 2012.

V. Jejčič, T. Godeša, M. Hočevar, B. Širok, A. Malneršič, A. Štrancar, M. Lešnik, D. Stanjko. Design and testing of an ultrasound system for targeted spraying in orchards. *Strojniški vestnik*, vol. 57, no. 7/8, str. 587-598, July-August 2011.

R. Rozman, D. M. Kodek. Using asymmetric windows in automatic speech recognition. *Speech Communication*, vol. 49, no. 4, pp. 268-276, April 2007.

D. M. Kodek and M. Krisper. Telescopic rounding for suboptimal finite wordlength FIR digital filter design. *Digital Signal Processing*, vol. 15, no. 6, pp. 522-535, Nov. 2005.

D. M. Kodek and M. Krisper. Optimal algorithm for minimizing production cycle time of a printed circuit board assembly line. *International Journal of Production Research*, vol. 42, no. 23, pp. 5031-5048, Dec. 2004.

D. Šonc. A version of the byte radix sort algorithm suitable for the implementation in hardware. *Proc. of Eurocon 2003 International Conference on Computer as a Tool*, Ljubljana, Slovenia, vol. 2, pp. 66-69, Sep. 22-24, 2003.

AWARDS AND RECOGNITIONS

Dušan M. Kodek, "Donald Michie and Alan Turing" Award for Life Achievements in Slovenian Information Society, 2013.

Software Engineering Laboratory

Phone: (+386 1) 4768 + ext.
www: <http://www.fri.uni-lj.si/en/laboratories/selab/>

Head:
Associate Professor
Viljan Mahnič, PhD

Staff	E-mail	Ext.
Associate Professor Viljan Mahnič, PhD	viljan.mahnic@fri.uni-lj.si	447
Senior Lecturer Igor Rožanc, PhD	igor.rozanc@fri.uni-lj.si	366
Assistant Marko Poženeš, PhD	marko.pozenes@fri.uni-lj.si	365
Assistant Luka Fürst, PhD	luka.fuerst@fri.uni-lj.si	365
Ext. Collaborator Nataša Zabkar, PhD	nzabkar@gmail.com	
Ext. Collaborator Anže Časar	anze.casar@fri.uni-lj.si	

RESEARCH ACTIVITIES

The Software Engineering Laboratory is involved in teaching and researching in the areas of Software Engineering and Information Systems with an emphasis on Agile Software Development Methods, Software Quality Management, Software Metrics, Graph Grammars, Information Systems Development, Information Systems Audit and Control, and Data Warehousing. The staff has recently worked on two international projects within the EC TEMPUS and INCO-COPERNICUS programmes, as well as on several development projects for the industry. The staff has also developed the University of Ljubljana student records information system. The following areas of research are currently being pursued:

1. In Agile Software Development Methods: Factors affecting successful adoption. Agile software project management. Balancing agility and discipline.

2. In Software Quality Management: Adaptation of CMMI to the needs of small organizations. Personal and Team Software Process. Quality assurance in agile projects.

3. *In Software Metrics*: Different approaches to software measurements (e.g. GQM, bottom-up). Measuring performance of agile software development methods. Definition of appropriate metrics for the development of applications in a database environment.

4. *In Graph Grammars and Graph Algorithms*: Graph grammars as a generalization of string grammars. Parsing graph grammars and translating graph-based languages. Graph grammar induction. Graph grammars in software engineering. Graph data mining and general graph algorithms.

5. *In Web Data Mining and User Behaviour Analysis*: Clickstream data mining. Using stochastic models for user behaviour analysis. Separating interleaved web sessions using heuristic methods and graph search algorithms.

6. *In Information Systems and Data Warehouses*: Agile methodologies for information systems development. Development of administrative and management information systems for higher education institutions. Information quality assessment and improvement.

7. *In Information Systems Audit and Control*: Investigation of systematic approaches (such as COBIT) to IT control and audit in order to help IT professionals in developing and maintaining information systems that would satisfy fiduciary, security and quality requirements.

8. *In Model Driven Development*: Reverse Engineering of Web Applications to produce Platform Independent Model

LABORATORY GUESTS

Assoc. Prof. Ladislav Samuelis, Technical University of Košice, Faculty of Electrical Engineering and Informatics, Department of Computers and Informatics, Košice, Slovak Republic. 2. 6. – 8. 6. 2013. Lectures: Advanced topics on OO SW metrics and Notes on teaching software testing.

SELECTED PUBLICATIONS

L. Fürst, M. Mernik, V. Mahnič. Converting metamodels to graph grammars: doing without advanced graph grammar features. To appear in *Software and Systems Modeling*, <http://link.springer.com/article/10.1007/978-3-319-013-0380-2#page-1>.

L. Fürst, V. Mahnič. Introductory programming course: motivating students with prior knowledge. *World Transactions on Engineering and Technology Education*, 11(4): 400-405, 2013.

I. Rožanc, B. Slivnik. Using reverse engineering to construct the platform independent model of a web application for student information systems. *Computer Science and Information Systems*, 10(4):1557-1583, 2013.

M. Poženeš. Assessing teamwork in a software engineering capstone course. *World transactions on engineering and technology education*, 11(1): 6-12, 2013.

V. Mahnič, T. Hovelja. On using planning poker for estimating user stories. *Journal of Systems and Software*, 85(9): 2086-2095, 2012.

V. Mahnič. A capstone course on agile software development using Scrum. *IEEE Transactions on education*, 55(1): 99-106, 2012.

L. Fürst, M. Mernik, V. Mahnič. Graph grammar induction as a parser-controlled heuristic search process. *Lecture notes in computer science*, 121-136, 2012.

V. Mahnič, N. Žabkar. Measuring progress of Scrum-based software projects. *Electronics and Electrical Engineering*, 18(8): 73-76, 2012.

L. Fürst, V. Mahnič. A cooperative development system for an interactive introductory programming course. *World transactions on engineering and technology education*, 10(2): 122-127.

I. Rožanc, B. Slivnik. Producing the platform independent model of an existing web application. V: GANZHA, Maria (ur.), MACIASZEK, Leszek (ur.), PAPRZYCKI, Marcin (ur.). *Proceedings of the Federated Conference on Computer Science and Information Systems, September 9-12, 2012, Wrocław, Poland: fedCSIS*. Warsaw: Polskie Towarzystwo Informatyczne, 2012, str. 1341-1348.

L. Fürst, M. Mernik, V. Mahnič. Improving the graph grammar parser of Rekers and Schürr. *IET Software*, 5(2): 246-261, 2011.

V. Mahnič. A case study on agile estimating and planning using Scrum. *Electronics and Electrical Engineering*, 2011. No. 5: 123-128, 2011.

V. Mahnič. Teaching Scrum through team-project work: students' perceptions and teacher's observations. *International Journal of Engineering Education*, 26(1): 96-110, 2010.

M. Poženeš, V. Mahnič, M. Kukar. Separation of interleaved Web sessions with heuristic search. 10th IEEE International Conference on Data Mining, 14-17 December 2010, Sydney, Australia., pp. 411-420.

M. Poženeš, V. Mahnič, M. Kukar. Separating interleaved HTTP sessions using a stochastic model. *Informatica (Ljublj.)*, 34(2): 199-205, 2010.

Computer Vision Laboratory

Head:

Full Professor
Franc Solina, PhD

Phone: (+386 1) 4768 + Ext.
www: <http://www.fri.uni-lj.si/en/laboratories/cvl/>

Staff	E-mail	Ext.
Full Professor Franc Solina, PhD	franc.solina@fri.uni-lj.si	389
Assistant Professor Narvika Bovcon, PhD	narvika.bovcon@fri.uni-lj.si	980
Assistant Professor Peter Peer, PhD	peter.peer@fri.uni-lj.si	253
Assistant Professor Luka Šajn, PhD	luka.sajn@fri.uni-lj.si	980
Senior Lecturer Borut Batagelj, PhD	borut.batagelj@fri.uni-lj.si	878
Assistant Aleš Jaklič, PhD	ales.jaklic@fri.uni-lj.si	980
Assistant Bojan Klemenc, BSc	bojan.klemenc@fri.uni-lj.si	878
Assistant Robert Ravnik, PhD	robert.ravnik@fri.uni-lj.si	878
Assistant Tadej Zupancič, BSc	tadej.zupancic@fri.uni-lj.si	878
Researcher Jernej Bule, BSc	jernejj.bule@fri.uni-lj.si	835
Young Researcher Andrej Ikica, MSc	andrej.ikica@fri.uni-lj.si	878
Young Researcher Jure Kovač, MSc	jure.kovac@fri.uni-lj.si	878
Laboratory Technician Miha Peternel, MSc	miha.peternel@fri.uni-lj.si	878

RESEARCH ACTIVITIES

The laboratory is dedicated to research in computer vision and multimedia in general.

Topics that are of interest are capture, processing and interpretation of 3D visual data, understanding and interpretation of the human form in images (face detection, face recognition, gait recognition, fingerprint recognition), machine learning in computer vision, and the use of images in computer-human interaction.

Application areas that we work in are interpretation of medical images, interactive visual signage systems, 3D documentation in archaeology and cultural heritage, multimedia applications for learning sign language,

recognition of text in natural and urban scenes, computer games, forensic analysis of images and video, analysis of images in sports, information design, and interactive new media art installations.

An ongoing collaboration with the New media department of the Academy of Fine Arts at the University of Ljubljana supports the creation of interactive art installations using the latest information technology.

Art projects serve as an excellent framework for testing research ideas in practical applications.

RESEARCH PROJECTS

Computer vision (P2-0214). Basic Research Programme, Slovenian Research Agency (2009-2014).

Consulting with 3D scanning and modeling in archaeology. Industry-Funded Project, Magelan skupina, raziskave, proizvodnja, trgovina in storitve, d.o.o., Kranj (2011-).

KC CLASS - Cloud Assisted Services (3211-10-000467). Structural Funds Project, Ministry of education, science and sport (2011-2013).

KC OPCOMM - Open Communication Platform for Service Integration (3211-10-000468). Structural Funds Project, Ministry of education, science and sport (2011-2013).

Text detection in images of natural scenes. Industry-Funded Project, Iks, d.o.o. (2009-2013).

Gait recognition. Industry-Funded Project, Mega M d.o.o. (2011-2014).

RESEARCH VISITS

Franc Solina: Center for Information Technology Research in the Interest of Society, UC Berkeley, 29. 5. – 3. 6. 2013. Discussion of common research topics.

INVITED TALKS AND LECTURES

Borut Batagelj: Dobro Vprašanje - Zakaj si možki ne zapomni, ko pride ženska od frizerja (oddaja na temo prepoznavanja obrazov). 12. 1. 2013, Radio Slovenija, 1. Program.

Narvika Bovcon: Graphic design and new media, 22. 5. 2013, an invited lecture at Akademija likovnih umetnosti, Univerza v Zagrebu.

Franc Solina: Dynamic anamorphosis. 30. 5. 2013, an invited lecture at Berkeley, University of California.

SELECTED PUBLICATIONS

R. Ravnik, B. Batagelj, B. Kverh, F. Solina. Dynamic anamorphosis as a special, computer-generated user interface. *Interacting with computers* 26(1): 46-62, 2014.

N. Bovcon. Atlas povečane resničnosti. *Dialogi* 49(7/8): 56-66, 2013.

A. Ikica, P. Peer. SWT voting-based color reduction for text detection in

natural scene images. *EURASIP journal on advances in signal processing* 2013(95): 1-26, 2013.

L. Cempre, A. Bešir, F. Solina. Dictionary of the Slovenian sign language on the WWW. *First International Conference, SouthCHI 2013*, Maribor, Slovenia, July 1-3, 2013. Human factors in computing and informatics : proceedings, (Lecture notes in computer science), str. 240-259, 2013.

N. Bovcon, A. Vaupotič, B. Klemenc, F. Solina. "Atlas 2012" augmented reality : a case study in the domain of fine arts. *First International Conference, SouthCHI 2013*, Maribor, Slovenia, July 1-3, 2013. Human factors in computing and informatics : proceedings, (Lecture notes in computer science), str. 477-496, 2013.

M. Hrastovec, F. Solina. Obtaining meteorological data from aircraft with Mode-S radars. *IEEE aerospace and electronic systems magazine* 28(12): 12-24, 2013.

P. Peer, J. Bule, J. Žganec Gros, V. Štruc. Building cloud-based biometric services. *Informatica* 37(1): 115-122, 2013

R. Ravnik, F. Solina. Audience measurement of digital signage : quantitative study in real-world environment using computer vision. *Interacting with computers* 25(3): 218-228, 2013.

R. Ravnik, F. Solina. Interactive and audience adaptive digital signage using real-time computer vision. *International journal of advanced robotic systems* 2013(10): str. 1-7, 2013.

N. Bovcon. Literarni vidiki novomedijskih del Jake Železnikarja in Sreča Dragana. *Primerjalna književnost* 36(1): 81-102, 2013.

A. Vaupotič, N. Bovcon. Obrat po prostorskem obratu : umetniškorskoraziskovalni pristop. *Primerjalna književnost* 36(2): 225-244, 2013.

J. Kovač, P. Peer. Transformation based walking speed normalization for gait recognition. *Transactions on internet and information systems* 7(11): 2690-2701, 2013.

M. Erič, R. Kovačič, G. Berginc, M. Pugelj, Ž. Stopinšek, F. Solina. The impact of the latest 3D technologies on the documentation of underwater heritage sites. *Proceedings of the 2013 Digital Heritage International Congress 2013*, 28 Oct - 1 Nov, Marseille, France : DigitalHeritage : federating the 19th Int'l VSMM, 10th Eurographics GCH, & 2nd UNESCO Memory of the World Conferences, plus special sessions from CAA, Arqueologica 2.0, Space2Place, ICOMOS ICIP & CIPA, EU projects, et al.. [S. l.]: IEEE, 2013, vol. 2, pp. 281-288, 2013.

M. Erič, F. Solina. Student Workshop on 3D Data Capture and Processing in Underwater Archaeology in Portorož, Slovenia. *Submerged heritage* 2013(3): 54-59, 2013.

A. Jaklič, A. Leonardis, F. Solina. *Segmentation and Recovery of Superquadrics*. Volume 20 of Computational Imaging and Vision. Kluwer, Dordrecht, 2010.

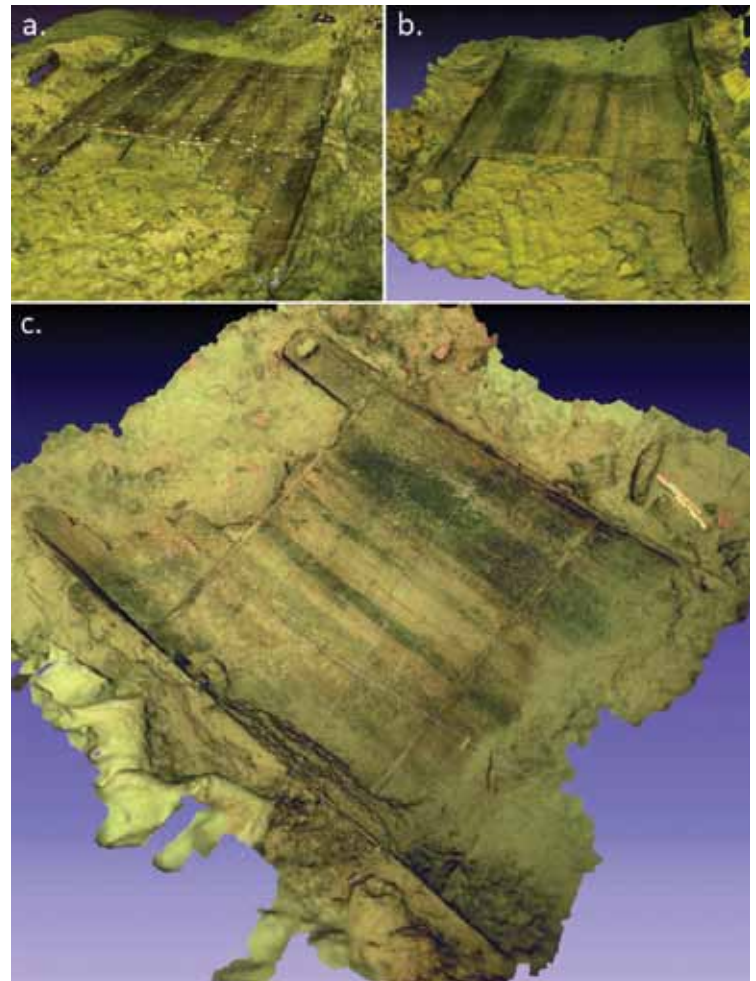

3D_model_LRV.jpg: 3D Model of a Roman barge captured underwater using photogrammetry in river Ljubljanica near Vrhnika (see article The impact of the latest 3D technologies on the documentation of underwater heritage sites)

F. Solina. 15 seconds of fame. *Leonardo*, 37(2):105-110+125, 2004.

J. Krivic, F. Solina. Part-level object recognition using superquadrics. *Computer Vision and Image Understanding*, 95(2): 105-126, 2004.

B. Prihavec, F. Solina. User interface for video observation over the internet. *Journal of Network and Computer Applications*, (21):219-237, 1998.

A. Leonardis, A. Jaklič, F. Solina. Superquadrics for segmentation and modeling range data. *IEEE Transactions on Pattern Recognition and Machine Intelligence*, 19(11):1289-1295, 1997.

F. Solina, R. Bajcsy. Recovery of parametric models from range images: The case for superquadrics with global deformations. *IEEE Transactions on Pattern Analysis and Machine Intelligence*, 12(2):131-147, 1990.



Big_brother_LRV.jpg: The big brother is watching you! : interactive art installation at Speculum Artium 2013, Apologists of the new civilization, Trbovlje, 10 -12 October 2013

EXHIBITIONS

B. Batagelj: 15 seconds of fame, IIT Bombay Techfest 2013, 3. 1. – 5. 1. 2013 (Invited project).

B. Batagelj, B. Klemenc, R. Ravnik, F. Solina: The big brother is watching you! : installation at Speculum Artium 2013, Apologists of the new civilization, Trbovlje, 10. 10. – 12. 10. 2013.

N. Bovcon, M. Buziol, J. Fingušt Prebil, E. Lucija Kozak, G. Krnc, D. Mahnič, V. Mervič, A. Vaupotič, T. Žbona: Atlas - Solkan 2013, Galerija Dimenzija napredka, Solkan, 14. 10. - 14. 11. 2013.

N. Bovcon, A. Vaupotič: Un Coup de dés: Slovenian Poetry in New Media, 11th International Comparative Literature Colloquium, Vilenica 2013, Koper, 12. 9. – 13. 9. 2013.

Visual Cognitive Systems Laboratory

Phone: (+386 1) 4768 + ext.
www: <http://www.vicos.si>

Head:
Assistant Professor
Danijel Skočaj, PhD

Staff	E-mail	Ext.
Full Professor Aleš Leonardis, PhD *	ales.leonardis@fri.uni-lj.si	189
Assistant Professor Danijel Skočaj, PhD	danijel.skocaj@fri.uni-lj.si	189
Assistant Professor Matej Kristan, PhD **	matej.kristan@fri.uni-lj.si	189
Assistant Professor Marko Boben, PhD ***	marko.boben@fri.uni-lj.si	181
Assistant Luka Čehovin, MSc	luka.cehovin@fri.uni-lj.si	189
Researcher Alen Vrečko	alen.vrecko@fri.uni-lj.si	769
Researcher Domen Tabernik	domen.tabernik@fri.uni-lj.si	181
Young Researcher Žiga Pavlin	ziga.pavlin@fri.uni-lj.si	769
PhD Student-Assistant Matjaž Majnik	matjaz.majnik@fri.uni-lj.si	181

* With the University of Birmingham, School of Computer Science, Centre for Computational Neuroscience and Cognitive Robotics, and 10 % with FRI.

** Also with the Machine Vision Laboratory at the Faculty of Electrical Engineering.

*** Also with the Laboratory for Mathematical Methods in Computer and Information Science.

RESEARCH ACTIVITIES

Visually enabled cognitive systems are intelligent artificial systems that use vision among other sensors in order to act and interact in everyday situations. Examples include mobile robots, intelligent environments, smart mobile devices, intelligent transportation systems, cognitive assistants, etc. The Visual Cognitive Systems Laboratory is involved in basic and applied research of such systems, with emphasis on visual learning, recognition, categorization, and tracking.

Research in the area of visually enabled cognitive systems focuses on various theories regarding requirements, architectures, forms of representation, kinds of ontologies and knowledge, and varieties of



Visual tracking using a smart mobile device

mechanisms relevant to integration and control of vision systems. In this context, cognitive vision implies functionalities for knowledge representation, learning, reasoning about events and structures, recognition and categorization, and goal specification, all of which are concerned with the semantics of the relationship between the visually enabled agent and its environment. This requires a vast effort in a multidisciplinary understanding of cognitive processes, involving studies in cognitive psychology, neuroscience, and linguistics.

In the past, our research in the area of visual learning and recognition has primarily focused on subspace methods, which enable direct view-based building of visual representations and subsequent visual recognition of objects, scenes, and activities. Our main research achievement in the framework of subspace methods is development of robust approaches to both learning and recognition. We have also developed methods for incremental subspace learning that enable updating of representations and therefore facilitate continuous life-long visual learning.

Recently, continuous learning has become a major topic of our research; we have been developing both, low-level incremental learning methods (based on mixture models), as well as a high-level general framework for continuous learning of categorical knowledge. This learning is performed in an interactive manner in a dialogue with a human; we have been exploring different learning strategies ranging from fully autonomous to completely tutor guided learning, in simulation as well as on real robots. Our research has also shifted towards learning scalable representations suitable for recognition and detection of a large number of object categories. Within this framework, we developed an approach which learns a hierarchy of spatially flexible compositions in an unsupervised, statistics-driven manner. Visual tracking has also been very important

research topic recently. We developed a novel coupled-layer visual model that combines the target's global and local appearance, leading to a more robust tracking through significant appearance changes. Applications include recognition of objects, scenes, and activities in visual cognitive tasks, such as surveillance and cognitive assistants. In mobile computing, we are developing methods that use visual context and geo-referenced intelligent maps for smart vision-based positioning, and for direct camera based interaction with objects in urban environments, as well as other computer vision approaches applicable on smart mobile devices.

EQUIPMENT

Our theoretical findings on visual tracking, learning and recognition are often integrated and implemented on mobile robots. Specifically, we use two in-door and one out-door mobile platforms equipped with monocular, omnidirectional, stereo, and RGBD camera setups. We are also implementing direct interaction and object manipulation with a Katana HD6M light weighted robot arm. The laboratory is also equipped with several low cost robotic mobile platforms such as TurteBots and AR.Drone quadcopters. On the other hand, the research in mobile computing is being integrated and tested on the state of the art mobile phones and tablets, which come equipped with numerous sensors and enough computing power and connectivity to support the development of ubiquitous visually aware cognitive agents. Both robots and gadgets shall ultimately be able to perceive and understand their environment through interaction, to categorize and recognize objects and subjects around them as well as actions they are performing, and will be able to communicate with humans and other agents on a semantic level.

RESEARCH PROJECTS

Computer vision (P2-0214). Basic Research Programme, Slovenian Research Agency (2009-2014).

Learning a large number of visual object categories for content-based retrieval in image and video databases (J2-3607). Basic Research Project, Slovenian Research Agency (2010-2013).

Learning, analysis, and detection of motion in the framework of a hierarchical compositional visual architecture (J2-4284). Basic Research Project, Slovenian Research Agency (2011-2014).

Development of a system for measuring feet with smart mobile devices, Industry-Funded Project, UCS d.o.o. (2013-2014).

Autonomous tracking and control for next-generation videoconferencing devices, Industry-Funded Project, Motrr (2013-2014).

RESEARCH VISITS

Danijel Skočaj: University of Birmingham, School of Computer Science, Birmingham, UK, 1. 1. – 15. 1. 2013. Research collaboration on development of intelligent interactive robot systems.

Luka Čehovin: University of Birmingham, School of Computer Science,

Birmingham, UK, 26.1. - 1.3.2013. Research collaboration on development algorithms for visual tracking.

Matej Kristan: University of Birmingham, School of Computer Science, Birmingham, UK, 27.2. - 9.6.2013. Research collaboration on development of generative models for online learning.

Luka Čehovin: University of Birmingham, School of Computer Science, Birmingham, UK, 26.1. - 1.3.2013. Research collaboration on development algorithms for visual tracking.

Danijel Skočaj: University of Birmingham, School of Computer Science, Birmingham, UK, 15. 7. - 1. 8. 2013. Research collaboration on intelligent robotics.

INVITED TALKS AND LECTURES

Matej Kristan: Online Kernel Density Estimation for learning and classification, 17. 5. 2013, an invited talk at the University of Birmingham, Birmingham, UK.

Matej Kristan: The Visual Object Tracking VOT2013 challenge results, 2. 12. 2013, an invited talk at the IEEE workshop on visual object detection challenge VOT2013, Sydney, Australia.

SELECTED PUBLICATIONS

M. Kristan, A. Leonardis. Online Discriminative Kernel Density Estimator with Gaussian Kernels. *IEEE transactions on cybernetics*, pp. 1-11., 2013.

N. Krüger, P. Janssen, S. Kalkan, M. Lappe, A. Leonardis, J. H. Piater, A. J. Rodríguez-Sánchez, L. Wiskott: Deep Hierarchies in the Primate Visual Cortex: What Can We Learn for Computer Vision? *IEEE Trans. Pattern Anal. Mach. Intell.* 35(8): 1847-1871, 2013.

P. Uršič, D. Tabernik, M. Boben, D. Skočaj, A. Leonardis, M. Kristan, Room categorization based on a hierarchical representation of space. *International journal of advanced robotic systems*, vol. 10, pp. 1-13, 2013.

L. Čehovin, M. Kristan, A. Leonardis. Robust Visual Tracking using an Adaptive Coupled-layer Visual Model. *IEEE Transactions on Pattern Analysis and Machine Intelligence*. pre-published. 2012.

A. Vrečko, A. Leonardis, D. Skočaj. Modeling binding and cross-modal learning in Markov Logic Networks. *Neurocomputing*, vol. 96, pp. 29-36, 2012.

M. Kristan, A. Leonardis, D. Skočaj. Multivariate online kernel density estimation with Gaussian kernels, *Pattern recogn*, pp. 2630-2642, 2011.

J. L. Wyatt, A. Aydemir, M. Brenner, M. Hanheide, N. Hawes, P. Jensfelt, M. Kristan, G. J. Kruijff, P. Lison, A. Pronobis, K. Sjöö, A. Vrečko, H. Zender, M. Zillich, D. Skočaj, Self-Understanding and Self-Extension: A Systems and Representational Approach. *IEEE Transactions on Autonomous Mental Development*, Vol. 2, no. 4, pp. 282 - 303, 2010.

S. Fidler, M. Boben, A. Leonardis. Learning Hierarchical Compositional



Integrated system for interactive learning in dialogue with a human

Representations of Object Structure. In: *Object Categorization: Computer and Human Vision Perspectives*, Editors: S. Dickinson, A. Leonardis, B. Schiele and M. J. Tarr, Cambridge University Press, 2009.

M. Kristan, D. Skočaj and A. Leonardis. Online Kernel Density Estimation for Interactive Learning. *Image and Vision Computing*, 2009.

B. Leibe, A. Leonardis and B. Schiele. Robust Object Detection with Interleaved Categorization and Segmentation. *International Journal of Computer Vision, Special Issue on Learning for Recognition and Recognition for Learning*, Vol. 77, no. 1-3, pp. 259-289, 2008.

D. Skočaj and A. Leonardis. Incremental and robust learning of subspace representations. *Image and Vision Computing*, vol. 26, no. 1, pp. 27-38, 2008.

D. Skočaj, A. Leonardis, and H. Bischof. Weighted and robust learning of subspace representations. *Pattern Recognition*, vol. 40, no. 5, pp. 1556-1569, May 2007.

S. Fidler, D. Skočaj, and A. Leonardis, "Combining reconstructive and discriminative subspace methods for robust classification and regression by subsampling", *IEEE Transactions on Pattern Analysis and Machine Intelligence*, vol. 28, no. 3, pp. 337-350, March, 2006.

M. Jogan, E. Žagar, A. Leonardis. Karhunen-Loeve expansion of a set of rotated templates. *IEEE Transactions on image processing*, 2003, Vol 12, No 7, pp. 817- 825, 2003.

A. Leonardis, H. Bischof, and J. Maver. "Multiple Eigenspaces", *Pattern Recognition*, 35, no. 11, pp. 2613-2627, 2002. Twenty-Ninth Annual

Pattern Recognition Society Award. Selected as the most original manuscript from all 2002 Pattern Recognition issues.

AWARDS AND RECOGNITIONS

Matej Kristan: Young University teachers and researchers award for excellent teaching and research achievements, awarded by the University of Ljubljana, 2013.

Luka Čehovin, Matej Kristan and Aleš Leonardis: Robust visual tracking using an adaptive coupled visual model, Excellent scientific achievements in 2012 award, awarded by the Slovenian Research Agency.

Matjaž Majnik and Danijel Skočaj, Active learning with teacher-learner mutuality, 22nd International Electrotechnical and Computer Science Conference ERK, 2013, best paper award in the Pattern recognition section.

Danijel Skočaj, Alen Vrečko and Matej Kristan, A system for interactive learning in dialogue with a human, Excellent scientific achievements in 2011 award, awarded by the Slovenian Research Agency.

ORGANISATION OF CONFERENCES AND WORKSHOPS

The 11th IEEE International Conference on Automatic Face and gesture Recognition, FG 2015, (A. Leonardis general co-chair, M. Kristan evaluation co-chair, D. Skočaj publication co-chair, L. Čehovin web chair).

IEEE Workshop on Visual Object Tracking VOT 2013 in conjunction with ICCV 2013, (M. Kristan, A. Leonardis members of organizing committee, L. Čehovin member of technical committee).

Artificial Intelligence Laboratory

Head:
Full Professor Ivan
Bratko, PhD

Phone: (+386 1) 4768 + ext.
www: <http://www.fri.uni-lj.si/ailab>

Staff	E-mail	Ext.
Full Professor Ivan Bratko, PhD	ivan.bratko@fri.uni-lj.si	393
Senior Lecturer Aleksander Sadikov, PhD	aleksander.sadikov@fri.uni-lj.si	987
Assistant Professor Matej Guid, PhD	matej.guid@fri.uni-lj.si	987
Assistant Martin Možina, PhD	martin.mozina@fri.uni-lj.si	154
Assistant Jure Žabkar, PhD	jure.zabkar@fri.uni-lj.si	154
Young Researcher Vida Groznik	vida.groznik@fri.uni-lj.si	987
Young Researcher Tadej Janež	tadej.janez@fri.uni-lj.si	154
Young Researcher Aljaž Košmerlj	aljaz.kosmerlj@fri.uni-lj.si	154
Young Researcher Timotej Lazar	timotej.lazar@fri.uni-lj.si	987
Young Researcher Domen Šoberl, MSc*	domen.soberl@fri.uni-lj.si	154

* from 1 December 2013

RESEARCH ACTIVITIES

The laboratory carries out research in machine learning, data mining, inductive logic programming, qualitative reasoning, and AI approaches to robotics, systems control, bioinformatics, and intelligent tutoring systems. A notable aspect of much of this research is its application to problems in medicine, robotics, intelligent tutoring systems, systems control, game playing and analysis, ecological modelling, and reconstruction of human control skill.

In 2013, project ParkinsonCheck (in collaboration with the Ljubljana Neurological Clinic) was finished with a mobile application to early screening for Parkinson's disease, based on spiralography diagnosis. Questions of automated knowledge acquisition for Intelligent Tutoring Systems and automated estimation of problem difficulty were further

investigated. An approach to qualitative modelling and qualitative planning in robotics was developed in a case application to a track wheeled rescue robot.

Laboratory's demo on autonomous robot learning by experimentation (<http://www.aillab.si/xpero/>, part of the XPERO project) was awarded the first prize at the European Exhibition in Future Emergent Technologies, Prague, April 2009. The Research Programme "Artificial Intelligence and Intelligent Systems", carried out in part by this laboratory, was in 2006 listed among the best research programmes funded by the Slovenian research agency ARRS. Two former members of this laboratory Aleks Jakulin and Dorian Šuc received the prestigious best European AI dissertation awards, sponsored by ECCAI (European Coord. Committee in AI). In 2007, Ivan Bratko received the national Zois award for outstanding scientific achievements. Aleksander Sadikov was elected by students as best lecturer in the faculty's study programmes in Computer Sc. and Mathematics in 2008, 2010 and 2011.

EQUIPMENT

The laboratory owns a NAO humanoid robot by Aldebaran Robotics and a motion capture sensor suit Animazoo IGS-190.

RESEARCH PROJECTS

Artificial Intelligence and Intelligent Systems (P2-0209). Research Programme, Slovenian Research Agency (2009-2014).

Machine Learning in Building Intelligent Tutoring Systems (J2-4222). Basic Research Project, Slovenian Research Agency (2011-2014).

Molecular and other prognosticators of lung cancer and mesothelioma (J3-4076). Basic Research Project, Slovenian Research Agency (2011-2014).

ParkinsCheck: timely detection and monitoring of Parkinson's disease. Structural Funds Project, Ministry of education, science and sports (2012-2013).

Machine learning for building intelligent tutoring systems: conceptualization of problem-solving domains (BI-US/13-14-031). Bilateral Collaboration Project Slovenia - USA, Slovenian Research Agency (2013-2014).

LABORATORY GUESTS

Timothy Wiley, University of New South Wales, Australia. 30. 1. - 2. 3. 2013. One month research visit on qualitative modelling of a track wheeled mobile robot.

Timothy Wiley, University of New South Wales, Australia. 20. 8. - 26. 8. 2013. One week research visit on qualitative modelling and planning of a track wheeled mobile robot.

Dayana Hristova. University of Vienna, Cognitive Science Master student. 1. 10. - 12. 12. 2013. Research project in estimating problem difficulty for people.



The AI Lab's Nao robot at the Future Emergent Technologies Exhibition, Prague, April 2009. The scientific message of the demonstration "A day in the life of the Nao robot" was to show how a robot can autonomously learn by performing experiments in its environment. The demonstration won the first prize at the exhibition.

Ana Tenorio, National Institute of Astrophysics, Optics and Electronics, Mexico. 30. 11. - 7. 12. 2013. One week research visit on symbolic learning of robot actions related to her PhD research.

INVITED TALKS AND LECTURES

Ivan Bratko: Selected Topics in Artificial Intelligence, June 2013, course at Alpe Adria University, Klagenfurt.

Ivan Bratko: Autonomous Discovery of Abstract Notions by a Robot, 10. 10. 2013, invited lecture at Imperial College, London.

Ivan Bratko: The Changing World of Artificial Intelligence. Knowledge and business challenge of globalization, 14. 11. 2013, opening plenary talk at the 5th International Scientific Conference, Celje.

SELECTED PUBLICATIONS

V. Groznik, M. Guid, A. Sadikov, M. Možina, D. Georgijev, V. Kragelj, S. Ribarič, Z. Pirtošek, I. Bratko. Elicitation of neurological knowledge with argument-based machine learning. *Artificial intelligence in medicine*. 2013, vol. 57, no. 2, pp. 133-144.

T. Janež, J. Žabkar, M. Možina, I. Bratko. Learning faster by discovering and exploiting object similarities. *International journal of advanced robotic systems*, 2013, vol. 10, str. 1-18.



J. Žabkar, M. Možina, I. Bratko, J. Demšar. Learning qualitative models from numerical data. Proc. 23rd International Joint Conference on Artificial Intelligence, *IJCAI-13*. Beijing, avgust, 2013, str. 305-309.

S. Modgil, I. Bratko, M. Možina. The added value of argumentation. V: S. Ossowski (ur.). *Agreement technologies*, (Law, governance and technology series, 8). Dordrecht: Springer, 2013, str. 357-403.

M. Guid, I. Bratko. Search-based estimation of problem difficulty for humans. V: C. H. Lane (ur.). *Artificial intelligence in education : AIED 2013 : 16th International Conference, Memphis, TN, USA, July 9-13, 2013 : proceedings*, (Lecture notes in computer science, SL 7, Lecture notes in artificial science, 7926). Berlin; Heidelberg: Springer, 2013, str. 860-863.

I. Bratko. *Prolog programming for artificial intelligence*. 4th ed. Harlow (England): Addison-Wesley / Pearson, cop. 2012. XXI + 673 pp.; previous editions also translated into German, Italian, French, Slovene, Japanese, and Russian.

A. Košmerlj, I. Bratko, J. Žabkar. Embodied concept discovery through qualitative action models. *Int. j. uncertain. fuzziness knowl.-based syst.*, 2011, vol. 19, no. 3, pp. 453-475.

J. Žabkar, M. Možina, I. Bratko, J. Demšar. Learning qualitative models from numerical data. *Artif. intell.* [Print ed.], 2011, vol. 175, no. 9/10, str. 1604-1619, ilustr.

M. Guid, I. Bratko. Using heuristic-search based engines for estimating human skill at chess. *ICGA journal*, 2011, vol. 34, no. 2, str. 71-81, ilustr.

I. Bratko. Autonomous discovery of abstract concepts by a robot. *Lect. notes comput. sci.*, part 1, str. 1-11, ilustr.

D. S. Nau, M. Luštrek, A. Parker, I. Bratko, M. Gams. When is it better not to look ahead? *Artificial Intelligence* 174 (2010) 1323-1338.

I. Bratko, J. Žabkar, M. Možina. Argument Base Machine Learning. In book *Argumentation in Artificial Intelligence*, Edited by Iyad Rahwan, Guillermo Simari, Springer Verlag 2009, pp. 463-482.

M. Možina, J. Žabkar, I. Bratko. Argument based machine learning. *Artificial Intelligence Journal* 171(10): 922-937, 2007.

M. Luštrek, M. Gams, I. Bratko. Is real-valued minimax pathological? *Artificial Intelligence* 170: 620-642, 2006.

M. Guid, I. Bratko. Computer analysis of world chess champions. *ICGA Journal* 29(2): 65-73, 2006.

A. Sadikov, I. Bratko. Learning long-term chess strategies from databases. *Machine Learning* 63(3): 329-340, 2006.

D. Šuc, D. Vladušič, I. Bratko. Qualitatively faithful quantitative prediction. *Artificial Intelligence*, 158(2): 189-214, 2004.

ORGANIZATION OF CONFERENCES

Ivan Bratko (program co-chair): Robotics Symposium. Slovenian Academy of Sciences and Arts. 27. 11. 2012.

Ivan Bratko (member of organizing committee): 100 Years of Turing and 40 Years of SLAIS, Ljubljana. 11. 10. 2012.

Laboratory for Cognitive Modelling

Head:

Full Professor
Igor Kononenko, PhD

Phone: (+386 1) 47 68 + ext.
www: <http://lkm.fri.uni-lj.si>

Staff	E-mail	Ext.
Full Professor Igor Kononenko, PhD	igor.kononenko@fri.uni-lj.si	390
Associate Prof Marko Robnik Šikonja, PhD	marko.robnik@fri.uni-lj.si	188
Assistant Professor Matjaž Kukar, PhD	matjaz.kukar@fri.uni-lj.si	914
Assistant Professor Zoran Bosnić, PhD	zoran.bosnic@fri.uni-lj.si	922
Assistant Petar Vračar, MSc	petar.vracar@fri.uni-lj.si	459
Assistant Darko Pevec, PhD	darko.pevec@fri.uni-lj.si	459
Researcher Erik Strumbelj, PhD	erik.strumbelj@fri.uni-lj.si	459
Young Researcher Miha Drole, BSc	miha.drole@fri.uni-lj.si	459
Young Researcher Jana Faganeli Pucer, BSc	jana.faganeli@fri.uni-lj.si	459
Young Researcher Domen Košir, BSc	domen.kosir@gmail.com	459
PhD Student-Assistant Kaja Zupanc, BSc	kaja.zupanc@fri.uni-lj.si	459
PhD Student-Assistant Matej Pičulin, BSc	matej.piculin@fri.uni-lj.si	459

RESEARCH ACTIVITIES

Laboratory for Cognitive Modelling (LKM) was officially founded in 2001. LKM carries out research in cognitive modelling, machine learning, neural networks, picture and data mining. Research results concern the modelling of noisy data related to cognitive, medical, biological and other processes. We are developing, testing and applying new approaches and algorithms for modelling from numeric, symbolic and pictorial data, and new approaches to building, evaluation and explanation of models, derived from data. Recent research is related to evaluating the utility of ordinal attributes, evaluating the reliability of single models' predictions in classification and regression, evaluating the reliability of clustering, explaining single predictions by arbitrary classification

and regression model, text summarization using archetypal analysis, analysing and modelling of sport data, user profiling by mining the web-logs, recommendation systems, learning of imbalanced classification problems, applying evolutionary computation to data mining focused on using ant colony optimization, prediction intervals which represent the distribution of individual future points in a more informative manner, spatial data mining with multi-level directed graphs, employing background knowledge analysis for search space reduction in inductive logic programming, detection of (non)-ischemic episodes in ECG signals, heuristic search methods in clickstream mining and mining of data streams. A notable aspect of much of this research is its application to problems in image analysis, medical diagnosis, ecological modelling, marketing and financial modelling.

RESEARCH PROJECTS

Artificial Intelligence and Intelligent Systems (P2-0209). Research Programme, Slovenian Research Agency (2009-2014).

A component for intelligent analysis of data streams. Industry-Funded Project, Optilab (2012-2013).

LABORATORY GUESTS

Prof. Dr. Zikrija Avdagić, University of Sarajevo, BIH. 27. 5. – 29. 5. 2013. Research collaboration on using AI for lung cancer diagnosis.

Dr. Aida Hajdarpašić, University of Sarajevo, BIH. 27. 5. – 29. 5. 2013. Research collaboration on using AI for lung cancer diagnosis.

Dino Kečo, MSc, University of Sarajevo, BIH. 27. 5. – 29. 5. 2013. Research collaboration on using AI for lung cancer diagnosis.

Prof. Dr. Tatjana Zrimec, Univerza na Primorskem, Koper. 20. 5. - 29. 5. 2013. Research collaboration on machine learning from lung cancer image data.

Ercan Canhas, MSc, University of Prizren, Kosovo. 4. 11. - 7. 11. 2013. Research collaboration on multidocument summarization based on archetypal analysis.

SELECTED PUBLICATIONS

I. Kononenko, M. Kukar: Machine Learning and Data Mining: Introduction to Principles and Algorithms, Horwood publ., 2007 (454 pages).

U. Ocepek, Z. Bosnić, I. Nančovska Šerbec, J. Rugelj. Exploring the relation between learning style models and preferred multimedia types. *Computers & Education*, Nov. 2013, vol. 69, pp. 343-355.

B. Petelin, I. Kononenko, V. Malačič, M. Kukar. Multi-level association rules and directed graphs for spatial data analysis. *Expert systems with applications*, 2013, vol. 40, issue 12, pp. 4957-4970

E. Canhasi, I Kononenko. Weighted archetypal analysis of the multi-element graph for query-focused multi-document summarization. *Expert systems with applications*, Feb. 2014, vol. 41, no. 2, pp. 535-543.

M. Robnik Šikonja, E. Štrumbelj, I. Kononenko. Efficiently explaining the predictions of a probabilistic radial basis function classification network. *Intelligent data analysis*, 2013, vol. 17, no. 5, pp. 791-802.

E. Štrumbelj, P. Vračar, M. Robnik Šikonja, B. Dežman, F. Erčulj. A decade of Euroleague basketball : an analysis of trends and recent rule change effects. *Journal of Human Kinetics*, 2013, vol. 38, pp. 183-189

E. Štrumbelj, I. Kononenko. Explaining prediction models and individual predictions with feature contributions. *Knowledge and information systems*, 2013, pp.1-19.

E. Canhasi, I. Kononenko. Multi-document summarization via Archetypal Analysis of the content-graph joint model. *Knowledge and information systems*, 2013, pp. 1-22.

Z. Bosnić, P.Vračar, M. Radović, G. Devedžić, N. Filipović., I. Kononenko. Mining data from hemodynamic simulations for generating prediction and explanation models. *IEEE trans. inf. technol. biomed.* Mar. 2012, vol. 16, no. 2, pp. 248-254, 1A1

M. Robnik-Šikonja, I. Kononenko, E. Štrumbelj. Quality of classification explanations with PRBF. *Neurocomputing*, Nov. 2012, vol. 96, pp. 37-46, 1A2

E. Štrumbelj, P.Vračar. Simulating a basketball match with a homogeneous Markov model and forecasting the outcome. *Int. j. forecast.* 2012, vol. 28, no. 2, pp. 532-542. 1A1

M. Kukar, I. Kononenko, C. Grošelj. Modern parameterization and explanation techniques in diagnostic decision support system : a case study in diagnostics of coronary artery disease. *Artif. intell. med.* Jun. 2011, vol. 52, no. 2, pp. 77-90, 1A2

E. Štrumbelj, M. Robnik-Šikonja. Online bookmakers' odds as forecasts : the case of European soccer leagues. *Int. j. forecast.* 2010, vol. 26, no. 3, pp. 482-488. 1A1

E. Štrumbelj, I. Kononenko: An efficient explanation of individual classifications using game theory. *J. Mach. Learn. Res.* 2010, 11[1]:1-18. 1A1

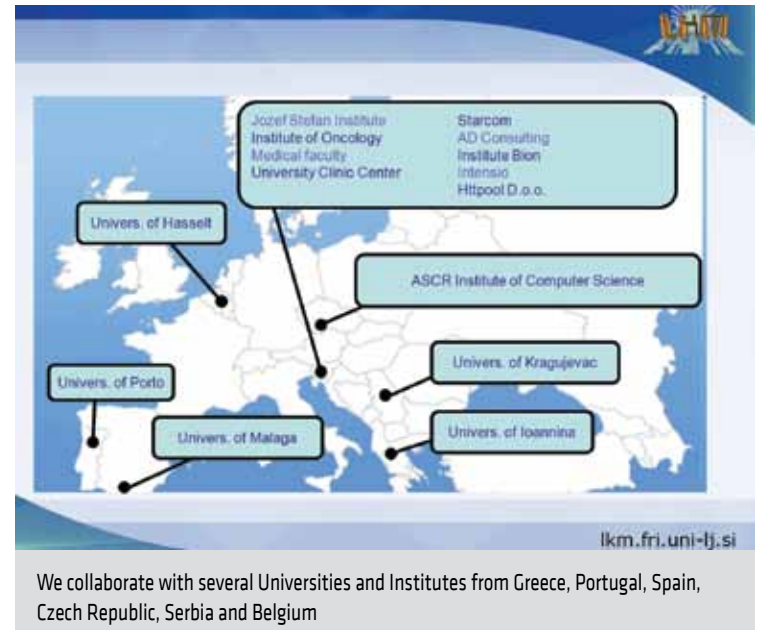
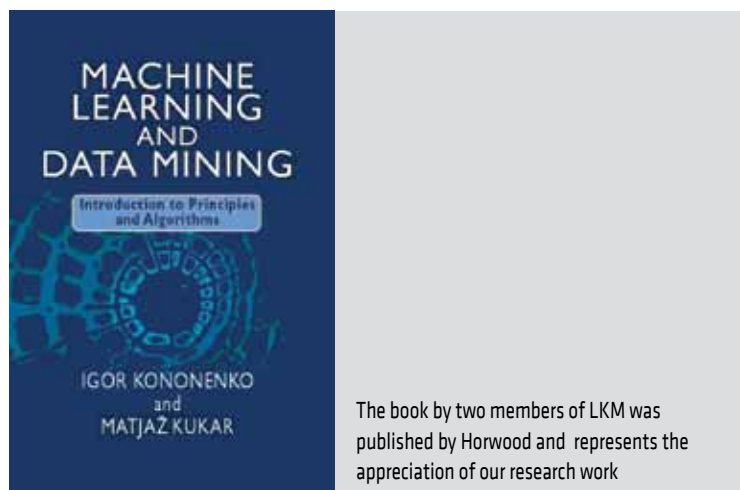

E. Štrumbelj, Z. Bosnić, I. Kononenko, B. Zakotnik, C. Grašič-Kuhar: Explanation and reliability of prediction models: the case of breast cancer recurrence. *Knowledge and information systems*, 24(2)305-324, 2010. 1A1

Bioinformatics Laboratory

Head:
Full Professor
Blaž Zupan, PhD

Phone: (+386 1) 4768 + ext.
www: <http://www.fri.uni-lj.si/lbi>

Staff	E-mail	Ext.
Professor Blaž Zupan, PhD	blaz.zupan@fri.uni-lj.si	402
Associate Professor Janez Demšar, PhD	janez.demsar@fri.uni-lj.si	813
Assistant Professor Tomaž Curk, PhD	tomaz.curk@fri.uni-lj.si	267
Professor Jernej Ule, PhD	j.ule@ucl.ac.uk	267
Assistant Jure Zbontar	jure.zbontar@fri.uni-lj.si	816
Researcher Gregor Rot	gregor.rot@fri.uni-lj.si	815
Researcher Miha Stajdohar, PhD	miha.stajdohar@fri.uni-lj.si	816
Researcher Črtomir Gorup	crtomir.gorup@fri.uni-lj.si	933
Researcher Marko Toplak	marko.toplak@fri.uni-lj.si	933
Researcher Adviti Naik	adviti.naik@fri.uni-lj.si	933
Young Researcher Lan Žagar	lan.zagar@fri.uni-lj.si	815
Young Researcher Anže Starič	anze.staric@fri.uni-lj.si	933
Young Researcher Marinka Žitnik	marinka.zitnik@fri.uni-lj.si	815
Young Researcher Tomaž Hočevar	tomaz.hocevar@fri.uni-lj.si	933
Young Researcher Matija Polajnar	matija.polajnar@fri.uni-lj.si	816
Young Researcher Niko Colnerič	niko.colneric@fri.uni-lj.si	
Laboratory Technician Aleš Erjavec	ales.erjavec@fri.uni-lj.si	933
Laboratory Technician Jure Bergant	jure.bergant@fri.uni-lj.si	

RESEARCH ACTIVITIES

Bioinformatics Laboratory performs research in data mining, analysis of big data, data fusion and techniques for data visualization. We apply our methods and algorithms to problems from molecular and system biology, functional genomics, chemogenomics and medicine. The lab maintains an open-source data mining package Orange (<http://www.aillab.si/>

orange) with an attractive and easy-to-use visual programming interface. Orange gained its popularity as the principal Python-based data mining tool and has a substantial community of users. We also maintain a set of interactive web-applications. These include dictyExpress (<http://www.aillab.si/dictyexpress>), a popular interactive exploratory data analytics tool that provides access to over 1,000 gene expression experiments on social amoeba *Dictyostelium discoideum*, SNPsyn (<http://snpsyn.bioblab.si>) for exploratory gene interaction analytics, and GenePath (<http://www.genepath.org>) for interactive epistasis analysis and gene network reconstruction from mutant-based phenotypes. GenePath is nearly 10 years old but still in frequent use in scholar institutions. In collaboration with MRC Laboratory of Molecular Biology in Cambridge we are also developing a computational pipeline for comprehensive analysis of next-generation high-throughput sequencing data (RNA-Seq and iCLIP) with the aim of modelling and understanding the molecular mechanisms associated with neurodegenerative diseases.

EQUIPMENT

10-node cluster (total 80 cores, 250 GHz, 200 GB RAM, 11 TB local storage).

7x IBM BladeCenter and DELL PowerEdge M620 blades (total 48 cores, 120 GHz, 1059 GB RAM, 4TB local storage).

60 TB of SAN and NAS storage.

Computer with Xeon Phi 5110P card (60 Pentium cores), two NVIDIA Tesla K20 cards (5760 cores) and 64 GB RAM (shared with Laboratory for Adaptive Systems and Parallel Processing).

RESEARCH PROJECTS

AXLE: Analytics for Xtremely Large European Data (FP7-318633). European Project (FP7), European Commission (2012-2015).

CARE-MI: Cardio Repair European Multidisciplinary Initiative (FP7-242038). EU FP7-HEALTH Programme project, European Commission (2010-2015).

Artificial intelligence and intelligent systems (P2-0209). Research Programme, Slovenian Research Agency (2009-2014).

CLIP: Mapping functional protein-RNA interactions to identify new targets for oligonucleotide-based therapy (ERC 206726 CLIP). ERC Project, European Research Council (2008-2013).

Growth and defense trade-offs in multitrophic interaction between potato and its two major pests (J4-4165). Basic Research Project, Slovenian Research Agency (2011-2014).

Evaluation of neuro-muscular trunk stabilization functions and development of exercise programmes for lower back pain prevention (L5-4293). Research Application Project, Slovenian Research Agency (2011-2014).

Combination of next generation sequencing and metagenomic analysis in the diagnostics of severe hop stunting (J4-4153). Basic Research Project (2011-2014).

Functional genomics of cholesterol homeostasis: the role of lanosterol 14 α -demethylase in development of metabolic disorders (J7-4053). Basic Research Project, Slovenian Research Agency (2011-2014).

Computational approaches for identification of bacterial resistance pathways in *Dictyostelium* (BI-US/13-14-016). Bilateral Collaboration Project, Slovenian Research Agency (2013-2014).

Functional genomics of potato-PVY interactions (J1-4268). Basic Research Project, Slovenian Research Agency (2011-2014).

Epidemiology and Biodiversity Studies of Plant Pathogens (L4-5525). Research Application Project (2013-2016).

Conquering the Curse of Dimensionality by Using Background Knowledge (J2-5480). Basic Research Project (2013-2016).

Post-transcriptional regulatory networks in neurodegenerative diseases (J7-5460). Basic Research Project (2013-2016).

LABORATORY GUESTS

Dr. Francesca Mulas, University of Pavia, Italy, 28. 5. - 31. 5.2013. Application of data fusion methods for inference of gene correlation networks from gene expressions in induced pluripotent stem cells.

Sanja Brdar, University of Novi Sad, Republika Srbija, 1. 2. - 31. 3. 2013. Research in matrix factorization methods for consensus clustering.

RESEARCH VISITS

Tomaž Curk: European Molecular Biology Laboratory (EMBL), Heidelberg, Germany, 1. 9. 2012 - 30. 6. 2013. Development of methods and software for genome-wide protein-RNA interaction analysis.

Blaž Zupan: Baylor College of Medicine, Department of Molecular and Human Genetics, Houston, USA. 1. 8. 2013 - 31. 7. 2014. Research in computational approaches for biomedical data analysis.

Marinka Žitnik: Baylor College of Medicine, Department of Molecular and Human Genetics, Houston, USA. 4. 12. 2013 - 4. 8. 2014. Research in data fusion and its applications in biomedicine.

Miha Štajdohar: Trento RISE, TechPeaks program, Trento, Italy. 29. 5. - 30. 11. 2013. Research in knowledge transfer between research institutions and industry.

SELECTED PUBLICATIONS

J. Demšar, T. Curk, A. Erjavec, Č. Gorup, T. Hočevar, M. Milutinović, M. Martin, M. Polajnar, M. Toplak, A. Starič, M. Štajdohar, L. Umek, L. Žagar, J. Žbontar, M. Žitnik, B. Zupan. Orange: data mining toolbox in Python. *Journal of Machine Learning Research*, 14: 2349-2353, 2013.

T. Hočevar, J. Demšar. A combinatorial approach to graphlet counting. *Bioinformatics*, 2013.

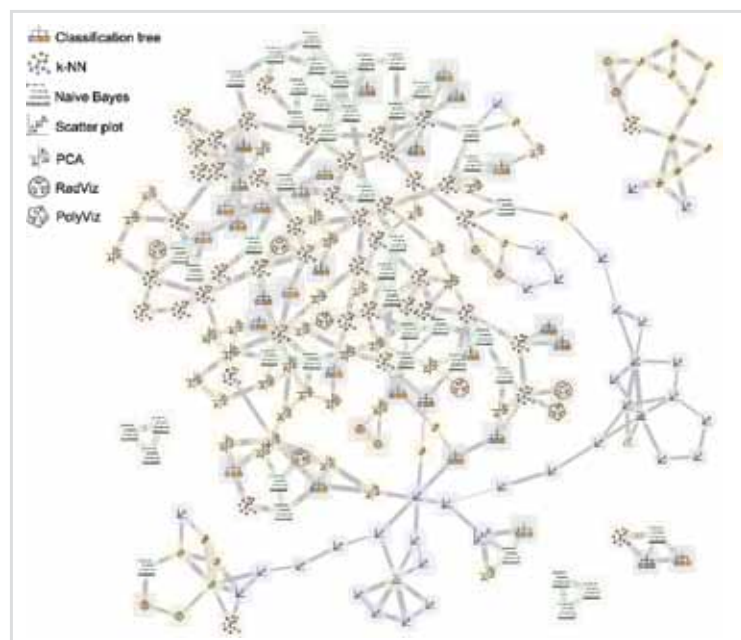

Model Map - a technique to explore the space of classification models. Models are organized into a network according to the similarity of their predictions. Model Map can help us understand black-box models, explore ensembles of models or extract rules that govern the data domain.

M. Žitnik, V. Janjić, C. Larminie, B. Zupan, N. Pržulj. Discovering disease-disease associations by fusing systems-level molecular data, *Scientific Reports*, 13:3202, 2013.

M. Štajdohar, J. Demšar. Interactive network exploration with Orange. *Journal of statistical software*, 53(6): 1-24, 2013.

R. Kršmanc, A. Šajn - Slak, J. Demšar. Statistical approach for forecasting road surface temperature. *Meteorological Applications*, 20(4): 439-446, 2013.

W. Nasser, B. Santhanam, E.R. Miranda, A. Parikh, K. Juneja, G. Rot, C. Dinh, R. Chen, B. Zupan, G. Shaulsky, A. Kuspa. Bacterial discrimination by dictyostelid amoebae reveals the complexity of ancient interspecies interactions, *Current Biology*, 23(10):862-872, 2013.

E. R. Miranda, O. Zhuchenko, M. Toplak, B. Santhanam, B. Zupan, A. Kuspa, G. Shaulsky. ABC transporters in *Dictyostelium discoideum* development, *PLoS One*, 8 (8). e70040, 2013.

M. Žitnik, B. Zupan. NIMFA: A Python library for nonnegative matrix factorization, *Journal of Machine Learning Research*, 13:849-853, 2012.

M.L. Änkö, M. Müller-McNicoll, H. Brandl, T. Curk, G. Črtomir, I. Henry, J. Ule, K.M. Neugebauer. The RNA-binding landscapes of two SR proteins reveal unique functions and binding to diverse RNA classes. *Genome Biology*, 13(3): R17, 2012.

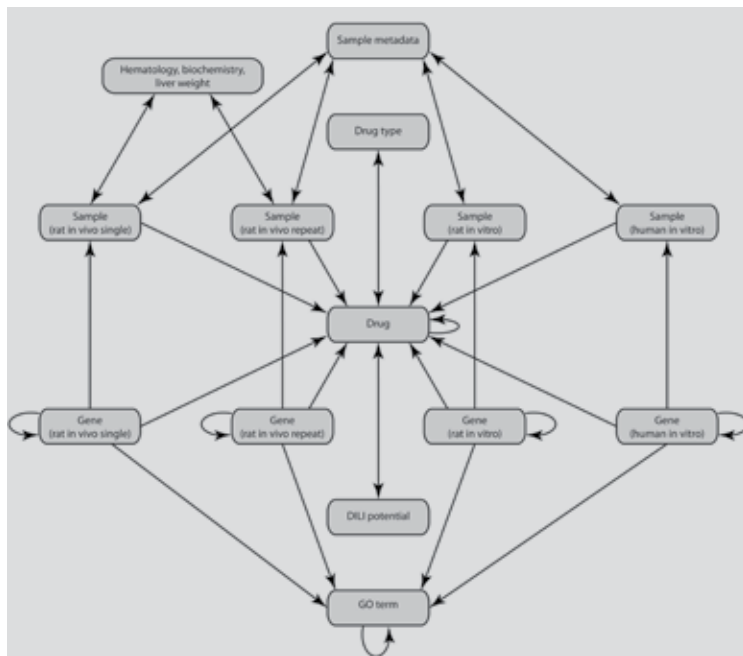

Data fusion configuration graph for our winning entry to a drug-induced liver injury data mining competition at Conference on Critical Assessment of Massive Data Sets (CAMDA2013, Berlin, Germany). The nodes represent 14 object types and arcs denote data sets that relate objects of different type or objects of the same type for a total of 29 fused data sets. Our data analysis shows that toxicological data sets fused together with a plethora of circumstantial evidence can boost the accuracy of drug toxicity prediction.

Y. Sugimoto, J. König, S. Hussain, B. Zupan, T. Curk, M. Frye, J. Ule. Analysis of CLIP and iCLIP methods for nucleotide-resolution studies of protein-RNA interactions. *Genome Biology*, 13(8): R67, 2012.

F. Mulas, L. Sacchi, L. Zagar, S. Garagna, M. Zuccotti, B. Zupan, R. Bellazzi. Knowledge-based bioinformatics for the study of mammalian oocytes, *International Journal of Developmental Biology*, 56 (10-12): 859-866, 2012.

J. Žabkar, M. Možina, I. Bratko, J. Demšar. Learning qualitative models from numerical data. *Artificial Intelligence*, 175(9/10): 1604-1619, 2011.

L. Žagar, F. Mulas, S. Garagna, Z. Maurizio, R. Bellazzi, B. Zupan. Stage prediction of embryonic stem cell differentiation from genome-wide expression data, *Bioinformatics*, 27(18): 2546-2553, 2011.

J. R. Tollrvey, T. Curk, B. Rogelj, M. Briese, M. Cereda, M. Kayikci, J. König, T. Hortobágyi, A. L. Nishimura, V. Župunski, R. Patani, S.

Chandran, G. Rot, B. Zupan, C. E. Shaw, J. Ule. Characterizing the RNA targets and position-dependent splicing regulation by TDP-43. *Nature Neuroscience*, 14(4): 452-459, 2011.

T. Curk, G. Rot, B. Zupan. SNPsyn: detection and exploration of SNP-SNP interactions. *Nucleic Acids Research*, 39(W444-9), 2011.

E. Huang, S. Talukder, T. R. Hughes, T. Curk, B. Zupan, G. Shaulsky, M. Katoh. Bzpf is a CREB-like transcription factor that regulates spore maturation and stability in *Dictyostelium*. *Developmental Biology*, 358(1): 137-146, 2011.

Z. Wang, M. Kayikci, M. Briese, K. Zarnack, N. M. Luscombe, G. Rot, B. Zupan, T. Curk, J. Ule. iCLIP predicts the dual splicing effects of TIA-RNA interactions. *PLoS Biology*, 8(10), 2010.

J. König, K. Zarnack, G. Rot, T. Curk, M. Kayikci, B. Zupan, D. J. Turner, N. M. Luscombe, J. Ule. iCLIP reveals the function of hnRNP particles in splicing at individual nucleotide resolution. *Nature Structural and Molecular Biology*, 17(7): 909-916, 2010.

G. Rot, A. Parikh, T. Curk, A. Kuspa, G. Shaulsky, B. Zupan: dictyExpress: a *D. discoideum* gene expression database with an explorative data analysis web-based interface. *BMC Bioinformatics*, 10: 265, 2009.

AWARDS AND RECOGNITIONS

Marinka Žitnik: First Prize for Excellent Research at ISMB/CAMDA Conference, Berlin, Germany, 2013.

Marinka Žitnik: PSB Travel Fellowship sponsored by ISCB, Hawaii, USA, 2014.

Marinka Žitnik: Scholarship for the Research Cooperation of Doctoral Students in the USA awarded by Slovene Human Resources Development Fund, 2013-14.

Slavko Žitnik, Marinka Žitnik: First Prize at Gene Regulation Network BioNLP Challenge, ACL, 2013.

Blaž Zupan: Fulbright Scholarship awarded by J. William Fulbright Scholarship Board, 2013-14.

Jure Žbontar: 5th place, The Marinexplore and Cornell University Whale Detection Challenge, 2013.

Laboratory for Mathematical Methods in Computer and Information Science

Head:

Associate Professor
Gašper Fijavž, PhD

Phone: (+386 1) 4768 + ext.
www: <http://www.fri.uni-lj.si/en/laboratories/lmat/>

Staff	E-mail	Ext.
Full Professor Neža Mramor Kosta, PhD	neza.mramor@fri.uni-lj.si	258
Associate Professor Bojan Orel, PhD	bojan.orel@fri.uni-lj.si	870
Associate Professor Gašper Fijavž, PhD	gasper.fijavz@fri.uni-lj.si	871
Assistant Professor Ganna Kudryavtseva, PhD	ganna.kudryavtseva@fri.uni-lj.si	883
Assistant Professor Polona Oblak, PhD	polona.oblak@fri.uni-lj.si	793
Assistant Professor Žiga Virk, PhD	ziga.virk@fri.uni-lj.si	871
Assistant Damir Franetič, PhD	damir.franetic@fri.uni-lj.si	866
Assistant Aleksandra Franc, PhD	aleksandra.franc@fri.uni-lj.si	866
Assistant Gregor Jerše, PhD	gregor.jerse@fri.uni-lj.si	866
Assistant Peter Marijan Kink, PhD	peter.kink@fri.uni-lj.si	866
Assistant Andrej Vodopivec, PhD	andrej.vodopivec@fri.uni-lj.si	883
Assistant Martin Vuk, PhD	martin.vuk@fri.uni-lj.si	883

RESEARCH ACTIVITIES

Members of the laboratory form the mathematical driving force at the Faculty of Computer and Information Sciences. As their role on the teaching part is to give lectures on the mathematical subjects to computer science students it is not surprising that they do not function as a homogeneous research group. Rather than that their cumulative research expertise should cover as large part of mathematical disciplines as possible. We are involved in research in the following areas of mathematics:

- algebraic topology, in particular algebraic invariants of topological spaces with group actions, as well as computational topology and topological data analysis,
- coarse geometry,
- semigroups and their interaction with automata theory and combinatorics; universal algebra,
- nonlinear dynamical systems and their application in geometry,
- commutative algebra and linear algebra, in particular, studying the variety of commuting nilpotent matrices over algebraically closed fields and certain classes of matrices over semi rings,
- Brownian motion and martingales and their applications to analysis,
- scientific computing and numerical solutions of differential equations,
- graph theory, topological and structural properties of graphs, and colourings problems of graphs,
- graph representations, connected with problems in computational geometry.

Some members of the lab participate in the research groups of the Institute of Mathematics, Physics, and Mechanics. We are also involved in joint research work with other research groups at the Faculty of Computer and Information Science and the Faculty of Electrical Engineering and with several institutions from abroad. University of Uppsala, Sweden, NTNU Trondheim, Norway, University of Tuebingen, Germany, Moscow State University, Russia, P. J. Šafarik University, Košice, Slovakia, University of Sevilla, Spain, Yokohama National University, Japan, Simon Fraser University, Canada, University of Melbourne, Australia, to mention only a few.

RESEARCH PROJECTS

Applied and Computational Algebraic Topology (ACAT). European Science Foundation Project (2011-2015).

LABORATORY GUESTS

Hanife Isal, Middle Eastern Technical University (METU), Ankara, Turkey, 24. 6. – 5. 7. 2013. The purpose of the visit was joint work with prof. Neža Mramor Kosta on the topic of her PhD dissertation from the field of computational topology. The visit was within the framework of the European Science Foundation Research networking programme Applied and Computational Algebraic Topology (ACAT).

Denis I. Saveliev, Moscow University, Moscow, Russia, 12. 9. – 20. 9. 2013. Research work with prof. Ganna Kudryavtseva in algebra and functional analysis.

RESEARCH VISITS

Ganna Kudryavtseva: Uppsala University, Sweden. 4. 2. – 13. 2. 2013, 10 days. Work on properties of multiseigroups.

Aleksandra Franc: KTH Royal Institute of Technology, Stockholm, Sweden. 16. 9. – 28. 9. 2013. Research on applications of topological complexity and other topological concepts in robotics.

Neža Mramor Kosta and Gregor Jerše, Universidad de Sevilla, Sevilla, Spain, 9. 9. – 15. 9. 2013. Visiting prof. Jose Antonio Vilches at the Department of Mathematics, University of Sevilla within the European Science Foundation Research networking programme Applied and Computational Algebraic Topology (ACAT).

Gašper Fijavž: Technische Univeritaet Ilmenau, Ilmenau, Germany, 8. 12. – 14. 12. 2013. Research on threshold colorings with prof. Matthias Kriesell.

Neža Mramor Kosta, Middle Eastern Technical University Ankara, Ankara, Turkey, 9. 12. – 15. 12. 2013. Visiting prof. Mehmetçik Pamuk, within the international bilateral research project with METU.

INVITED TALKS AND LECTURES

Ganna Kudryavtseva: Quantales, inverse semigroups and etale groupoids, 12. 2. 2013, an invited talk at Uppsala University, Uppsala, Sweden.

Ganna Kudryavtseva: Etale groupoids and their morphisms, 10. 4. – 12. 4. 2013, an invited talk at Semigroup Representations 2013 conference, ICMS, Edinburgh, Scotland, UK.

Neža Mramor Kosta: Parametric discrete Morse theory, 17. 7. 2013, an invited talk at Applied and Computational Algebraic Topology workshop, Universität Bremen, Germany.

Ganna Kudryavtseva: Non-commutative Stone dualities, 28. 7. – 2. 8. 2013, an invited talk at Duality in computer science workshop, Schloss Dagstuhl - Leibniz Center for Informatics, Dagstuhl, Germany.

Ganna Kudryavtseva: Non-commutative Stone dualities, 3. 12. 2013, an invited talk at Zagreb University, Zagreb, Croatia.

Neža Mramor Kosta: Topology and data, 12. 12. 2013, an invited talk at METU, Department of Mathematics, Ankara, Turkey.

SELECTED PUBLICATIONS

M. J. Alam, S. Chaplick, G. Fijavž, M. Kaufmann, S. G. Kobourov and S. Pupyrev. Threshold-Coloring and Unit-Cube Contact Representation of Graphs, *Lecture Notes in Computer Science*, 8165, pp 26-37, 2013.

R. Ayala, J. A. Vilches, G. Jerše and N. Mramor Kosta. Discrete gradient fields on infinite complexes. *Discrete and continuous dynamical systems*. 30(3):623-639, 2011.

A. Bauer, K. Cvetko-Vah, M. Gehrke, S. van Gool and G. Kudryavtseva. A non-commutative Priestley duality, *Topology and its Applications*, 160 (12):1423--1438, 2013.

D. Dolžan, M. Konvalinka and P. Oblak. Diameters of connected components of commuting graphs. *The electronic journal of linear algebra*, 26: 433-445, 2013.

G. Dolinar, A. E. Guterman, B. Kuzma and P. Oblak. Extremal matrix

centralizers. *Linear Algebra and its Applications*, 438(7): 2904-2910, 2013.

A. Franc and P. Pavešič. Lower bounds for topological complexity, *Topology and its Applications*, 160:991-1004, 2013.

A. Franc. Konfiguracijski prostori in topološka kompleksnost (Configuration spaces and topological complexity), *Obzornik za matematiko in fiziko*, 60:81-91, 2013.

G. Kudryavtseva. A dualizing object approach to non-commutative Stone duality, *Journal of Australian Mathematical Society*, 95:383-403, 2013.

G. Kudryavtseva and M. V. Lawson. The structure of generalized inverse semigroups, *Semigroup Forum*. 1-18, 2013.

T. Miyata and Ž. Virk. Dimension-Raising Maps in a Large Scale. *Fundamenta Mathematicae*. 223:83-97, 2013.

Ž. Virk and A. Zastrow. A homotopically Hausdorff space which does not admit a generalized universal covering space. *Topology and its Applications* 160:656-666, 2013.

Ž. Virk. Realizations of Countable Groups as Fundamental Groups of Compacta. *Mediterranean Journal of Mathematics*. 10:1573-1589, 2013.

B. Orel and A. Perne. *Computations with half-range Chebyshev polynomials*, *Journal of computational and applied mathematics*. 236:1753-1765, 2012.

D. Franetič and P. Pavešič. H-spaces, semiperfect rings and self-homotopy equivalences. *Proceedings of the Royal Society of Edinburgh: Section A Mathematics*. 141:1263-1277, 2011.

SUMMER SCHOOL

Laboratory members Neža Mramor Kosta, Aleksandra Franc and Gregor Jerše organized a highly successful Summer School on Computational Topology and Topological Data Analysis, Ljubljana, Slovenia between July 1st and 4th 2013. The other two members of the organizing committee Sergio Cabello Justo and Petar Pavešič come from Department of Mathematics, Faculty of Mathematics and Physics.

Laboratory for Cryptography and Computer Security

Head:

Full Professor
Aleksandar Jurišić,
PhD

Phone: +386 1 4768 +ext.
www: <http://lkrv.fri.uni-lj.si/>,
[http://www.fri.uni-lj.si/en/
laboratories/lccs/](http://www.fri.uni-lj.si/en/laboratories/lccs/)

Staff	E-mail	Ext.
Full Professor Aleksandar Jurišić, PhD	aj@fri.uni-lj.si	183
Assistant Peter Nose, BSc	peter.nose@fri.uni-lj.si	185
Assistant Janoš Vidali, PhD	janos.vidali@fri.uni-lj.si	185

RESEARCH ACTIVITIES

Our laboratory focuses on cryptography and computer security. We also study coding theory and statistical design.

With the dramatic development of telecommunications and information processing the demand for information is rapidly increasing. However, with the electronic revolution, information faces new and potentially more damaging security threats. It is namely much easier to intercept and alter electronic information than its paper predecessor, and besides, attack can be delivered remotely.

Information and computer security describes all measures taken to make services available and to prevent unauthorized use of electronic data, regardless whether it takes the form of *disclosure, alteration and destruction* of the data concerned, or *verification of authenticity and data integrity*, such as *digital cash* (carrier of value) and *digital signature*. Among preventive measures, *cryptography* provides the highest security in accordance with its flexibility for digital media. Cryptography and computer security influences cryptographic systems and applications for *networks* (Internet), *finances* (banks, stock market) and *telecommunications*. In particular we focus on public-key cryptosystems based on elliptic curves, algorithmic number theory, applications of finite fields and coding theory.

The main mathematical background for cryptology is algebraic combinatorics (including number theory and discrete mathematics), which is being used in two other important areas of our activity: *statistical design theory and coding theory*. The first one provides an optimal search for sample-sets and is being used, for example, in the design of digital communications. The second one constructs data carriers known as error-correcting codes (e.g. for CDs, wireless communication, satellites), since it is too expensive and inefficient to prevent all errors and it is easier to correct them (e.g. CD with a hole of 1mm in diameter still produces a perfect sound).

EQUIPMENT

Xilinx Virtex 6 FPGA Evaluation Kit
VIA Artigo Pico-ITX A1000
VIA Amos-5000
VIA EITX-3000

RESEARCH PROJECTS

E-uganke (E-puzzles), E-service and Mobile Applications, Slovenian Ministry of Education, Science and Sport, Republic of Slovenia and IMFM (2012 - 2013).

LABORATORY GUEST

Jovan Golić, Telecom Italia, Torino. 26. 12. – 31. 12. 2013. Identifying possibilities for cooperation in the field of cryptography.

RESEARCH VISITS

Aleksandar Jurišić: Kanazawa University, Kanazawa, Japan, 28. 12. 2012 – 4. 1. 2013. Research visit to Prof. Tatsuhiro Ito and Prof. Paul Terwilliger.



Colossus was the first electronic computer, used by British codebreakers during World War II for cryptanalysis of the Lorenz cipher



Aleksandar Jurišić: Department of Computer Science, Tohoku University, Sendai, Japan, 1. 12. 2012 – 8. 2. 2013. Research visit to Prof. Akihiro Munemasa, Prof. Hajime Tanaka and Prof. Jack Koolen, as a part of Aleksandar Jurišić's sabbatical.

INVITED TALKS AND LECTURES

Aleksandar Jurišić: Tight distance-regular graphs with classical parameters, 5. 1. – 6. 1. 2013, a talk at the Workshop on Algebraic Graph Theory, Spectral Graph Theory and Related Topics, the Nagoya University, Japan.

Aleksandar Jurišić: Tower graphs and extended generalized quadrangles, 25. 1. 2013, a talk at the Combinatorics Seminar in Kyushu University, Hakata/Fukuoka, Japan.

SELECTED PUBLICATIONS

P. Nose: Security weaknesses of a signature scheme and authenticated key agreement protocols, *Inf. Process. Lett.* 114 (2014), 107-115.

A. Jurišić and J. Vidali: Extremal 1-codes in distance-regular graphs of diameter 3, *Des. Codes Cryptogr.*, 65 (2012), 29-47.

M. Deza, E. Deza and J. Vidali: Cones of Weighted and Partial Metrics, *Algebra 2010 : Advances in Algebraic Structures* (2011), 177-197.

P. Nose: Security weaknesses of authenticated key agreement protocols, *Inf. Process. Lett.* 111 (2011), 687-696.

A. Jurišić and J. H. Koolen, Classification of the family $AT_4(qs, q, q)$ of antipodal tight graphs, *J. Combin. Theory (A)* 118 (2011), 842-852.

J. Vidali, P. Nose and E. Pašalić: Collisions for variants of the BLAKE hash function, *Inf. Process. Lett.* 110 (2010), 585-590.

A. Jurišić, P. Terwilliger and A. Žitnik, The Q -polynomial idempotents of distance-regular graphs, *J. Combin. Theory (B)* 100 (2010), 683-690.

A. Jurišić and P. Terwilliger, Pseudo-1-homogeneous distance-regular graphs, *Journal of Algebraic Combinatorics* 28 (2008), 509-529.

A. E. Brouwer, A. Jurišić and J. H. Koolen, Characterization of the Patterson graph, *J. of Algebra* 320 (2008), 1186-1199.

K. Coolsaet and A. Jurišić, Using equality in the Krein conditions to prove nonexistence of certain distance-regular graphs, *J. Combin. Theory (A)* 115 (2008), 1086-1095.

UNIVERZA V LJUBLJANI
FAKULTETA ZA RAČUNALNIŠTVO IN INFORMATIKO
Survey of Activities in 2013
ISSN 1408-2152

Edited by: Prof. Matjaž B. Jurič, PhD and Jasna Bevk, MA

Published by: FRI

Layout: Barbara Bogataj Kokalj

Printing: Medium d.o.o.

Number of copies: 200

NORMAL AUDIO

UNIVERZA V LJUBLJANI
FAKULTETA ZA RAČUNALNIŠTVO
IN INFORMATIKO

Tržaška cesta 25
T: +386 1 476 84 95
www.fri.uni-lj.si